

1

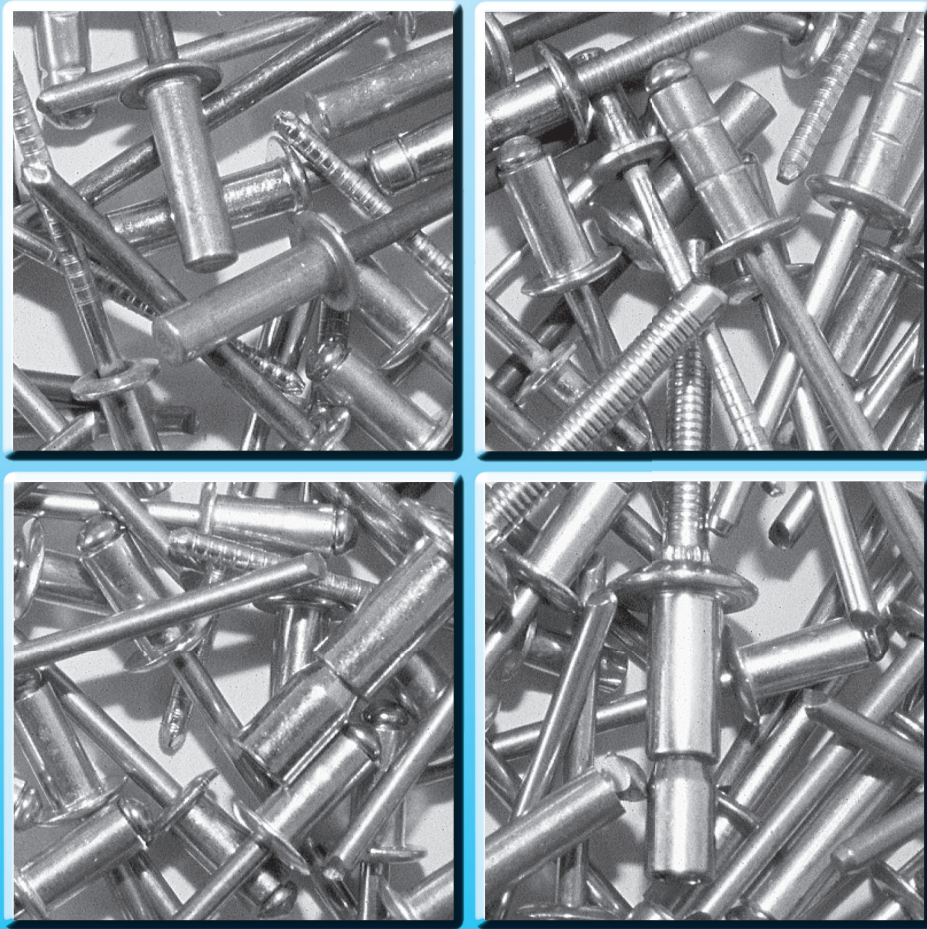

RIVETTI A STRAPPO

BLIND RIVETS

BLINDNIETE

RIVETS AVEUGLES

REMACHES CLAVO

FIXI

RIVETTI A STRAPPO

BLIND RIVETS

BLINDNIETE

RIVETS AVEUGLES

REMACHES CLAVO

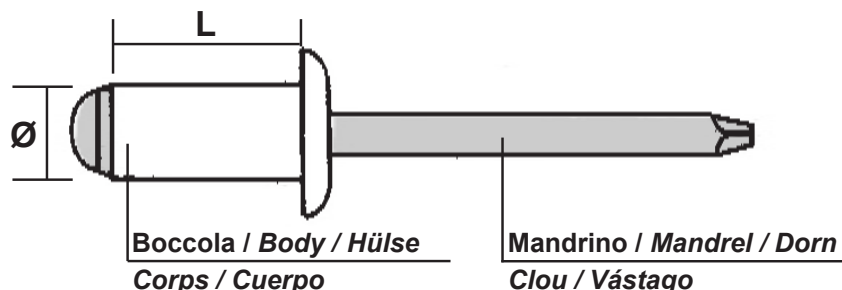

Come scegliere il foro sulla lamiera = Ø boccola + 0,1

Esempio: se il diametro del rivetto è Ø 4,8

$\text{Ø } 4,8 + 0,1 = 4,9 \text{ mm}$

I

Come scegliere la lunghezza del rivetto = spessore da serrare + Ø boccola

Esempio: se lo spessore da rivettare è 4 mm ed il diametro del rivetto è Ø 6

$4 + \text{Ø } 6 = 10 \text{ mm}$

Guarda i video di come funzionano i rivetti su www.fixi.it

How to choose the hole size = Ø body + 0,1

Example: if the rivet diameter is Ø 4,8

$\text{Ø } 4,8 + 0,1 = 4,9 \text{ mm}$

EN

How to choose the rivet length = material thickness + Ø body

Example: if the material thickness is 4 mm and the rivet diameter is Ø 6

$4 + \text{Ø } 6 = 10 \text{ mm}$

View how rivets work at www.fixi.it

Wie wählt man den Bohrlochdurchmesser = Ø Hülse + 0,1

Beispiel: bei Blindnietdurchmesser Ø 4,8

$\text{Ø } 4,8 + 0,1 = 4,9 \text{ mm}$

D

Wie wählt man die Blindnietlänge = Materialstärke + Ø Hülse

Beispiel: bei Materialstärke von 4 mm und Blindnietdurchmesser von Ø 6

$4 + \text{Ø } 6 = 10 \text{ mm}$

Siehe wie Blindniete verwendet werden unter www.fixi.it

Comment choisir le diamètre du trou = Ø corps + 0,1

Exemple: si le diamètre du rivet est Ø 4,8

$\text{Ø } 4,8 + 0,1 = 4,9 \text{ mm}$

F

Comment choisir la longueur du rivet = épaisseur à serrer + Ø corps

Exemple: si l'épaisseur à serrer est de 4 mm et le diamètre du corps est Ø 6

$4 + \text{Ø } 6 = 10 \text{ mm}$

Regardez le fonctionnement des rivets sur www.fixi.it

Como escoger el taladro para la chapa = Ø cuerpo + 0,1

Ejemplo: si el diámetro del remache clavo es de Ø 4,8

$\text{Ø } 4,8 + 0,1 = 4,9 \text{ mm}$

ES

Como escoger la longitud del remache clavo = espesor a remachar + Ø cuerpo

Ejemplo: si el espesor a remachar es de 4 mm y el diámetro del remache clavo es de Ø 6

$4 + \text{Ø } 6 = 10 \text{ mm}$

Puede ver como fucionan los remaches clavo en www.fixi.it







INDICE GENERALE



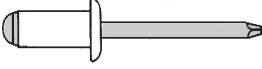

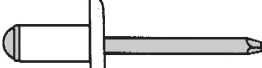

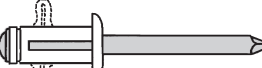
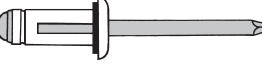
GENERAL INDEX

INHALTSVERZEICHNIS

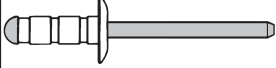
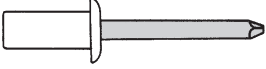
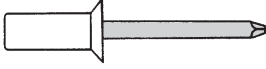
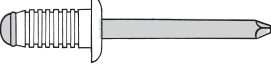
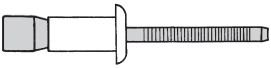
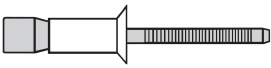
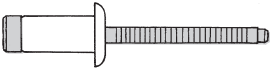
SOMMAIRE GÉNÉRAL

INDICE GENERAL

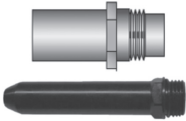
	ALLUMINIO-ACCIAIO ALUMINIUM-STEEL	ACCIAIO-ACCIAIO STEEL-STEEL	INOX-INOX STAINLESS STEEL- STAINLESS STEEL	ALLUMINIO-ALLUMINIO ALUMINIUM-ALUMINIUM	ALLUMINIO-INOX ALUMINIUM- STAINLESS STEEL	RAME-ACCIAIO COPPER-STEEL RAME-OTTONE COPPER-BRASS	RAME-A2 COPPER-A2 CUPRO NICHEL-A2 COPPER NICKEL-A2
	PAGINA / PAGE	PAGINA / PAGE	PAGINA / PAGE	PAGINA / PAGE	PAGINA / PAGE	PAGINA / PAGE	PAGINA / PAGE
 TESTA TONDA DOME HEAD	5 - 6 - 7	22	27 - 30	14	11	34	35
 TESTA SVASATA COUNTERSUNK HEAD	8	23	28				
 TESTA LARGA LARGE HEAD	9		29				
 TESTA EXTRA LARGA EXTRA LARGE HEAD	9		29				
 RIVETTI IN BLISTER DA 100 PZ RIVETS IN PACKAGING OF 100 PCS	10						
 TESTA TONDA DOME HEAD	12						
 TESTA TONDA DOME HEAD		23		13			
 TESTA TONDA DOME HEAD				13			
 TESTA TONDA DOME HEAD	15	24			18		
 TESTA SVASATA COUNTERSUNK HEAD	16						

	ALLUMINIO-ACCIAIO ALUMINIUM-STEEL	ACCIAIO-ACCIAIO STEEL-STEEL	INOX-INOX STAINLESS STEEL- STAINLESS STEEL	ALLUMINIO-ALLUMINIO ALUMINIUM-ALUMINIUM	ALLUMINIO-INOX ALUMINIUM- STAINLESS STEEL	RAME-ACCIAIO COPPER-STEEL RAME-OTTONE COPPER-BRASS	RAME-A2 COPPER-A2 CUPRO NICHEL-A2 COPPER NICKEL- A2
	PAGINA / PAGE	PAGINA / PAGE	PAGINA / PAGE	PAGINA / PAGE	PAGINA / PAGE	PAGINA / PAGE	PAGINA / PAGE
 TESTA LARGA - LARGE HEAD TESTA EXTRA LARGA - EXTRA LARGE HEAD	17						
 TESTA TONDA DOME HEAD	19	24	31		20	35	35
 TESTA SVASATA COUNTERSUNK HEAD	19						
 TESTA TONDA DOME HEAD	20						
 TESTA TONDA DOME HEAD		25	32	21			
 TESTA SVASATA COUNTERSUNK HEAD		25	32	21			
 TESTA TONDA DOME HEAD		26	33				
			36				
	37 - 38 - 39 - 40						
	41						
	42						

RIVETTI ALLUMINIO / ACCIAIO ZINCATO TESTA TONDA

BLIND RIVETS ALUMINIUM / STEEL ZINC PLATED DOME HEAD

BLINDNIETE ALUMINIUM / STAHL VZ FLACHKOPF

RIVETS ALUMINIUM / ACIER ZINGUÉ TÊTE PLATE

REMACHES ALUMINIO / ACERO CINCADO CABEZA ALOMADA

D +0,08/-0,15	L +1/-0,2	T max	K max	∅ foro/hole		CODICE code		
2,4	4	5,0	1,0	2,5 - 2,6		01AL2404TT	350 N	250 N
	5					01AL2405TT		
	6					01AL2406TT		
	8					01AL2408TT		
	10					01AL2410TT		
	12					01AL2412TT		
3,0	4	6,3	1,3	3,1 - 3,2		01AL3004TT	550 N	400 N
	5					01AL3005TT		
	6					01AL3006TT		
	7					01AL3007TT		
	8					01AL3008TT		
	9					01AL3009TT		
	10					01AL3010TT		
	11					01AL3011TT		
	12					01AL3012TT		
	14					01AL3014TT		
	16					01AL3016TT		
	18					01AL3018TT		
20	01AL3020TT							
3,2	5	6,7	1,3	3,3 - 3,4		01AL3205TT	700 N	500 N
	6					01AL3206TT		
	7					01AL3207TT		
	8					01AL3208TT		
	9					01AL3209TT		
	10					01AL3210TT		
	11					01AL3211TT		
	12					01AL3212TT		
	14					01AL3214TT		
	16					01AL3216TT		
	18					01AL3218TT		
	20					01AL3220TT		
25	01AL3225TT							
3,4	5	7,1	1,4	3,5 - 3,6		01AL3405TT	700 N	500 N
	7					01AL3407TT		
	9					01AL3409TT		
	11					01AL3411TT		
	14					01AL3414TT		
	16					01AL3416TT		
	18					01AL3418TT		

AL - TT

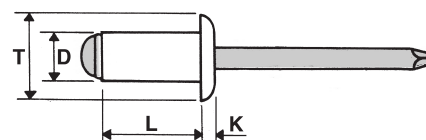

- RIVETTI VERNICIATI A RICHIESTA
- PAINTED RIVETS ON DEMAND
- LACKIERTE BLINDNIETE AUF ANFRAGE
- RIVETS PEINTS SUR DEMANDE
- REMACHES CLAVO PINTADOS BAJO SOLICITUD

RIVETTI ALLUMINIO / ACCIAIO ZINCATO TESTA TONDA

BLIND RIVETS ALUMINIUM / STEEL ZINC PLATED DOME HEAD

BLINDNIETE ALUMINIUM / STAHL VZ FLACHKOPF

RIVETS ALUMINIUM / ACIER ZINGUÉ TÊTE PLATE

REMACHES ALUMINIO / ACERO ZINCADO CABEZA ALOMADA

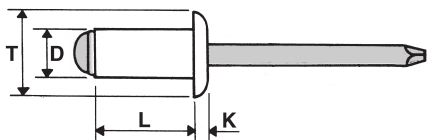
AL - TT

D	L	T	K	∅		CODICE		
+0,08/-0,15	+1/-0,2	max	max	foro/hole		code	min	min
4,0	5	8,4	1,7	4,1 - 4,2	0,5 - 1,5	01AL4005TT	1200 N	850 N
	6				1 - 3	01AL4006TT		
	7				2 - 3,5	01AL4007TT		
	8				3 - 5	01AL4008TT		
	9				4 - 5,5	01AL4009TT		
	10				5 - 6,5	01AL4010TT		
	11				6 - 7,5	01AL4011TT		
	12				6,5 - 8,5	01AL4012TT		
	14				8,5 - 10,5	01AL4014TT		
	16				10,5 - 12,5	01AL4016TT		
	18				12,5 - 14,5	01AL4018TT		
	20				12,5 - 16,5	01AL4020TT		
	22				16,5 - 18,5	01AL4022TT		
	24				18,5 - 20,5	01AL4024TT		
	26				20,5 - 22,5	01AL4026TT		
	28				22 - 24,5	01AL4028TT		
30	24 - 26,5	01AL4030TT						
35	26,5 - 31,5	01AL4035TT						
4,8	6	10,1	2,0	4,9 - 5,0	1 - 2,5	01AL4806TT	1700 N	1200 N
	7				1,5 - 3	01AL4807TT		
	8				2,5 - 4	01AL4808TT		
	9				3,5 - 5	01AL4809TT		
	10				4 - 6	01AL4810TT		
	11				5,5 - 7	01AL4811TT		
	12				6 - 8	01AL4812TT		
	14				7,5 - 10	01AL4814TT		
	16				9,5 - 12	01AL4816TT		
	18				11,5 - 14	01AL4818TT		
	20				13,5 - 16	01AL4820TT		
	22				15,5 - 18	01AL4822TT		
	24				16 - 20	01AL4824TT		
	26				19,5 - 22	01AL4826TT		
	28				21,5 - 24	01AL4828TT		
	30				22 - 25	01AL4830TT		
35	25 - 30	01AL4835TT						
40	30 - 35	01AL4840TT						
45	35 - 40	01AL4845TT						
50	40 - 45	01AL4850TT						
55	45 - 50	01AL4855TT						
60	50 - 55	01AL4860TT						
65	55 - 60	01AL4865TT						
70	60 - 65	01AL4870TT						

- RIVETTI VERNICIATI A RICHIESTA
- PAINTED RIVETS ON DEMAND
- LACKIERTE BLINDNIETE AUF ANFRAGE
- RIVETS PEINTS SUR DEMANDE
- REMACHES CLAVO PINTADOS BAJO SOLICITUD



RIVETTI ALLUMINIO / ACCIAIO ZINCATO TESTA TONDA

BLIND RIVETS ALUMINIUM / STEEL ZINC PLATED DOME HEAD

BLINDNIETE ALUMINIUM / STAHL VZ FLACHKOPF

RIVETS ALUMINIUM / ACIER ZINGUÉ TÊTE PLATE

REMACHES ALUMINIO / ACERO CINCADO CABEZA ALOMADA

D +0,08/-0,15	L +1/-0,2	T max	K max	∅ foro/hole		CODICE code		
5,0	6	10,5	2,1	5,1 - 5,2	1 - 2,5	01AL5006TT	2000 N	1400 N
	8				2,5 - 4	01AL5008TT		
	10				4 - 6	01AL5010TT		
	12				6 - 8	01AL5012TT		
	14				7,5 - 10	01AL5014TT		
	16				9,5 - 12	01AL5016TT		
	18				11,5 - 14	01AL5018TT		
	20				13,5 - 16	01AL5020TT		
6,0	8	12,6	2,5	6,1 - 6,2	2 - 3	01AL6008TT	3000 N	2100 N
	10				2,5 - 5	01AL6010TT		
	12				4,5 - 7	01AL6012TT		
	14				6 - 9	01AL6014TT		
	16				7 - 10	01AL6016TT		
	18				9,5 - 13	01AL6018TT		
	20				11 - 14	01AL6020TT		
	22				13 - 17	01AL6022TT		
	26				16,5 - 21	01AL6026TT		
	30				20,5 - 25	01AL6030TT		
6,4	10	13,4	2,7	6,5 - 6,6	2 - 5	01AL6410TT	3150 N	2200 N
	12				4,5 - 7	01AL6412TT		
	16				6,5 - 10	01AL6416TT		
	18				9,5 - 13	01AL6418TT		
	22				12,5 - 17	01AL6422TT		
	26				16,5 - 21	01AL6426TT		
	30				20 - 25	01AL6430TT		
	35				25 - 30	01AL6435TT		
40	30 - 35	01AL6440TT						

AL - TT

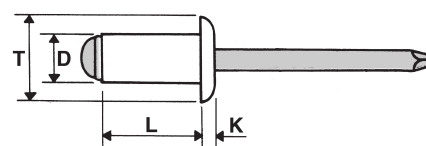

- RIVETTI VERNICIATI A RICHIESTA
- PAINTED RIVETS ON DEMAND
- LACKIERTE BLINDNIETE AUF ANFRAGE
- RIVETS PEINTS SUR DEMANDE
- REMACHES CLAVO PINTADOS BAJO SOLICITUD

RIVETTI ALLUMINIO / ACCIAIO ZINCATO TESTA SVASATA

BLIND RIVETS ALUMINIUM / STEEL ZINC PLATED COUNTERSUNK HEAD

BLINDNIETE ALUMINIUM / STAHL VZ SENKKOPF

RIVETS ALUMINIUM / ACIER ZINGUÉ TÊTE FRAISÉE

REMACHES ALUMINIO / ACERO ZINCADO CABEZA AVELLANADA

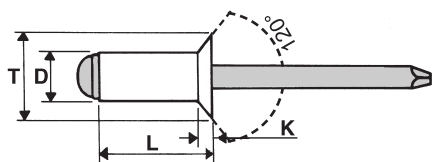
AL - TS

D	L	T	K	∅		CODICE		
+0,08/-0,15	+1/-0,2	max	max	foro/hole		code	min	min
2,4	5	5,0	1,0	2,5 - 2,6	2 - 3	01AL2405TS	350 N	250 N
	6				2 - 4	01AL2406TS		
	8				4 - 6	01AL2408TS		
	10				6 - 8	01AL2410TS		
3,0	6	6,3	1,3	3,1 - 3,2	1,5 - 3,5	01AL3006TS	550 N	400 N
	7				2 - 4	01AL3007TS		
	8				3,5 - 5,5	01AL3008TS		
	9				4 - 6	01AL3009TS		
	10				5,5 - 7	01AL3010TS		
	11				6 - 8	01AL3011TS		
	12				7 - 9	01AL3012TS		
	14				9 - 12	01AL3014TS		
3,2	6	6,7	1,3	3,3 - 3,4	1,5 - 3,5	01AL3206TS	700 N	500 N
	7				2 - 4	01AL3207TS		
	8				3 - 5	01AL3208TS		
	9				4 - 6	01AL3209TS		
	10				5 - 7	01AL3210TS		
	11				6 - 8	01AL3211TS		
	12				7 - 9	01AL3212TS		
	14				8 - 11	01AL3214TS		
4,0	6	8,4	1,7	4,1 - 4,2	1,5 - 3	01AL4006TS	1200 N	850 N
	7				2,5 - 4	01AL4007TS		
	8				3 - 5	01AL4008TS		
	9				3,5 - 6	01AL4009TS		
	10				5 - 7	01AL4010TS		
	11				5,5 - 8	01AL4011TS		
	12				7 - 9	01AL4012TS		
	14				8,5 - 11	01AL4014TS		
4,8	7	10,1	2,0	4,9 - 5,0	2,5 - 4	01AL4807TS	1700 N	1200 N
	8				3 - 4	01AL4808TS		
	9				3,5 - 5	01AL4809TS		
	10				4 - 6	01AL4810TS		
	11				4,5 - 7	01AL4811TS		
	12				6 - 8	01AL4812TS		
	14				7,5 - 10	01AL4814TS		
	16				9,5 - 12	01AL4816TS		
26	18	10,1	2,0	4,9 - 5,0	11,5 - 14	01AL4818TS	1700 N	1200 N
	20				12 - 16	01AL4820TS		
	26				16 - 22	01AL4826TS		
	30				22 - 26	01AL4830TS		
35	35	10,1	2,0	4,9 - 5,0	25 - 30	01AL4835TS	1700 N	1200 N

- RIVETTI VERNICIATI A RICHIESTA
- PAINTED RIVETS ON DEMAND
- LACKIERTE BLINDNIETE AUF ANFRAGE
- RIVETS PEINTS SUR DEMANDE
- REMACHES CLAVO PINTADOS BAJO SOLICITUD

RIVETTI ALLUMINIO / ACCIAIO ZINC. TESTA LARGA - EXTRALARGA

BLIND RIVETS ALUMINIUM / STEEL ZINC PLATED LARGE - EXTRA LARGE HEAD

BLINDNIETE ALUMINIUM / STAHL VZ GROßKOPF - EXTRA GROßKOPF

RIVETS ALUMINIUM / ACIER ZINGUÉ TÊTE LARGE - EXTRA LARGE

REMACHES ALUMINIO / ACERO CINCADO CABEZA GRANDE - EXTRA GRANDE

D +0,08/-0,15	L +1/-0,2	T	K max	∅ foro/hole		CODICE code		
3,2	6	8,8 - 10	2,0	3,3 - 3,4	1 - 3	01AL3206TL	700 N	500 N
	8				3 - 5	01AL3208TL		
	10				5 - 7	01AL3210TL		
	12				7 - 9	01AL3212TL		
	14				9 - 11	01AL3214TL		
	16				11 - 13	01AL3216TL		
4,0	6	8,8 - 10	2,5	4,1 - 4,2	1 - 3	01AL4006TL	1200 N	850 N
	8				3 - 5	01AL4008TL		
	10				5 - 6,5	01AL4010TL		
	12				6,5 - 8,5	01AL4012TL		
	14				8,5 - 10,5	01AL4014TL		
	16				10,5 - 12,5	01AL4016TL		
4,8	8	13 - 14	2,5	4,9 - 5,0	2,5 - 4	01AL4808TL	1700 N	1200 N
	10				4 - 6	01AL4810TL		
	12				6 - 8	01AL4812TL		
	14				7,5 - 10	01AL4814TL		
	16				9,5 - 12	01AL4816TL		
	18				11,5 - 14	01AL4818TL		
	20				13,5 - 16	01AL4820TL		
	24				16 - 20	01AL4824TL		
	26				19,5 - 22	01AL4826TL		
	30				22 - 25	01AL4830TL		
	35				25 - 30	01AL4835TL		
	40				30 - 35	01AL4840TL		

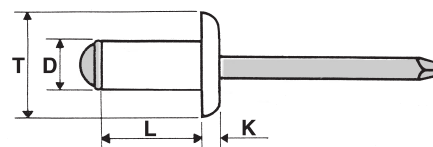
AL - TL

- RIVETTI VERNICIATI A RICHIESTA
- PAINTED RIVETS ON DEMAND
- LACKIERTE BLINDNIETE AUF ANFRAGE
- RIVETS PEINTS SUR DEMANDE
- REMACHES CLAVO PINTADOS BAJO SOLICITUD

D +0,08/-0,15	L +1/-0,2	T	K max	∅ foro/hole		CODICE code		
4,0	8	11 - 12	2,5	4,1 - 4,2	3 - 5	01AL4008TXL	1200 N	850 N
	10				5 - 6,5	01AL4010TXL		
	12				6,5 - 8,5	01AL4012TXL		
	14				8,5 - 10,5	01AL4014TXL		
	16				10,5 - 12,5	01AL4016TXL		
	20				12,5 - 16,5	01AL4020TXL		
4,8	8	15 - 16	2,5	4,9 - 5,0	2,5 - 4	01AL4808TXL	1700 N	1200 N
	10				4 - 6	01AL4810TXL		
	12				6 - 8	01AL4812TXL		
	14				7,5 - 10	01AL4814TXL		
	16				9,5 - 12	01AL4816TXL		
	18				11,5 - 14	01AL4818TXL		
	20				13,5 - 16	01AL4820TXL		
	24				16 - 20	01AL4824TXL		
	26				19,5 - 22	01AL4826TXL		
	30				22 - 25	01AL4830TXL		
	35				25 - 30	01AL4835TXL		
	40				30 - 35	01AL4840TXL		

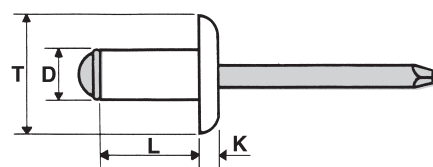
AL - TXL

- RIVETTI VERNICIATI A RICHIESTA
- PAINTED RIVETS ON DEMAND
- LACKIERTE BLINDNIETE AUF ANFRAGE
- RIVETS PEINTS SUR DEMANDE
- REMACHES CLAVO PINTADOS BAJO SOLICITUD

RIVETTI ALLUMINIO / ACCIAIO TESTA TONDA IN BLISTER DA 100 PEZZI
BLIND RIVETS ALUMINIUM / STEEL DOME HEAD IN BLISTER PACKAGING OF 100 PIECES
BLINDNIETE ALUMINIUM / STAHL FLACHKOPF IN BLISTER VERPACKUNG A 100 STÜCK
RIVETS ALUMINIUM / ACIER TÊTE PLATE EN SACHETS DE 100 PIÈCES
REMACHES ALUMINIO / ACERO CABEZA ALOMADA EN BOLSAS DE 100 UNIDADES

AL - TTBLI

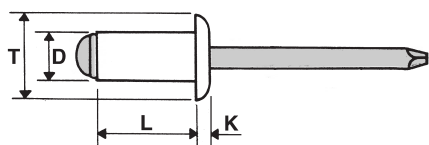

D +0,08/-0,15	L +1/-0,2	T max	K max	∅ foro/hole		CODICE code		
							min	min
3,0	6	6,3	1,3	3,1 - 3,2	1 - 3	01AL3006TTBLI	550 N	400 N
	8				3 - 5	01AL3008TTBLI		
	10				5 - 7	01AL3010TTBLI		
	12				7 - 9	01AL3012TTBLI		
3,2	8	6,7	1,3	3,3 - 3,4	3 - 5	01AL3208TTBLI	700 N	500 N
	10				5 - 7	01AL3210TTBLI		
	12				7 - 9	01AL3212TTBLI		
4,0	6	8,4	1,7	4,1 - 4,2	1 - 3	01AL4006TTBLI	1200 N	850 N
	8				3 - 5	01AL4008TTBLI		
	10				5 - 6,5	01AL4010TTBLI		
	12				6,5 - 8,5	01AL4012TTBLI		
	14				8,5 - 10,5	01AL4014TTBLI		
	16				10,5 - 12,5	01AL4016TTBLI		
4,8	8	10,1	2,0	4,9 - 5,0	2,5 - 4	01AL4808TTBLI	1700 N	1200 N
	10				4 - 6	01AL4810TTBLI		
	12				6 - 8	01AL4812TTBLI		
	14				7,5 - 10	01AL4814TTBLI		
	16				9,5 - 12	01AL4816TTBLI		
	20				13,5 - 16	01AL4820TTBLI		







RIVETTI ALLUMINIO / INOX A2 TESTA TONDA

BLIND RIVETS ALUMINIUM / STAINLESS STEEL A2 DOME HEAD

BLINDNIETE ALUMINIUM / EDELSTAHL A2 FLACHKOPF

RIVETS ALUMINIUM / INOX A2 TÊTE PLATE

REMACHES ALUMINIO / INOX A2 CABEZA ALOMADA

D +0,08/-0,15	L +1/-0,2	T max	K max	∅ foro/hole		CODICE code	 min	 min
3,0	6	6,3	1,3	3,1 - 3,2		1,5 - 3,5 01ALX3006TT	870 N	680 N
	8					3,5 - 5,5 01ALX3008TT		
	10					5,5 - 7 01ALX3010TT		
	12					7 - 9 01ALX3012TT		
	14					9 - 11 01ALX3014TT		
3,2	6	6,7	1,3	3,3 - 3,4		1,5 - 3,5 01ALX3206TT	980 N	760 N
	8					3,5 - 5,5 01ALX3208TT		
	10					5,5 - 7 01ALX3210TT		
	12					7 - 9 01ALX3212TT		
4,0	6	8,4	1,7	4,1 - 4,2		1,5 - 3 01ALX4006TT	1600 N	1200 N
	8					3 - 5 01ALX4008TT		
	10					5 - 6,5 01ALX4010TT		
	12					6,5 - 8,5 01ALX4012TT		
	14					8,5 - 10,5 01ALX4014TT		
	16					10,5 - 12,5 01ALX4016TT		
	20					12,5 - 16,5 01ALX4020TT		
4,8	6	10,1	2,0	4,9 - 5,0		0,5 - 2,5 01ALX4806TT	2250 N	1700 N
	8					2,5 - 4 01ALX4808TT		
	10					4 - 6 01ALX4810TT		
	12					6 - 8 01ALX4812TT		
	14					8 - 10 01ALX4814TT		
	16					10 - 12 01ALX4816TT		
	18					12 - 14 01ALX4818TT		
	20					14 - 16 01ALX4820TT		
	26					16 - 22 01ALX4826TT		
	30					22 - 26 01ALX4830TT		

ALX - TT

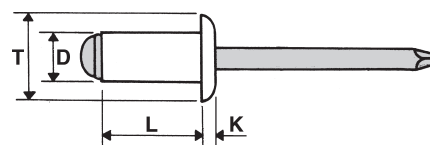

- A RICHIESTA DISPONIBILI CON TESTA SVASATA
 - COUNTERSUNK HEAD AVAILABLE ON DEMAND
 - SENKKOPF BLINDNIETE AUF ANFRAGE LIEFERBAR
 - SUR DEMANDE DISPONIBLES AUSSI TÊTE FRAISÉE
 - BAJO PEDIDO DISPONIBLES CON CABEZA AVELLANADA

RIVETTI PER MATERIE PLASTICHE ALLUMINIO / ACCIAIO ZINCATO T. TONDA

PEEL RIVETS ALUMINIUM / STEEL ZINC PLATED DOME HEAD

SPREIZBLINDNIETE ALUMINIUM / STAHL VZ FLACHKOPF

RIVETS ÉCLATÉS ALUMINIUM / ACIER ZINGUÉ TÊTE PLATE

REMACHES PARA MATERIAS PLASTICAS ALUMINIO / ACERO CINCADO CABEZA ALOMADA

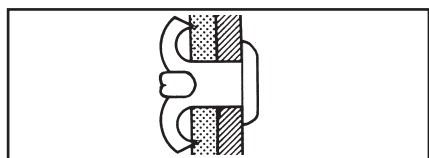
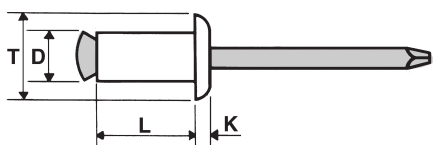
FA - TT

D +0,08/-0,15	L +1/-0,2	T max	K max	∅ foro/hole		CODICE code		
							min	min
3,2	8	6,7	1,3	3,7	0,5 - 1	01FA3208TT	700 N	765 N
	10					01FA3210TT		
	12					01FA3212TT		
4,0	10	8,4	1,7	4,5	1,5 - 5	01FA4010TT	1150 N	1260 N
	12					01FA4012TT		
	14					01FA4014TT		
	16					01FA4016TT		
	18					01FA4018TT		
	20					01FA4020TT		
	25					01FA4025TT		
	30					01FA4030TT		
4,8	10	10,1	2,0	5,3	0,5 - 4	01FA4810TT	1800 N	1600 N
	12					01FA4812TT		
	14					01FA4814TT		
	16					01FA4816TT		
	18					01FA4818TT		
	20					01FA4820TT		
	24					01FA4824TT		
	25					01FA4825TT		
	30					01FA4830TT		
	35					01FA4835TT		
	40					01FA4840TT		
	45					01FA4845TT		
50	01FA4850TT							





RIVETTI PER MATERIE PLASTICHE ALLUMINIO / ALLUMINIO TESTA TONDA

BLIND RIVETS FOR PLASTIC ALUMINIUM / ALUMINIUM DOME HEAD

LASCHENBLINDNIETE ALUMINIUM / ALUMINIUM FLACHKOPF





RIVETS POUR PLASTIQUE ALUMINIUM / ALUMINIUM TÊTE PLATE

REMACHES PARA MATERIAS PLASTICAS ALUMINIO / ALUMINIO CABEZA ALOMADA

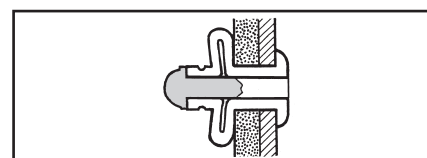
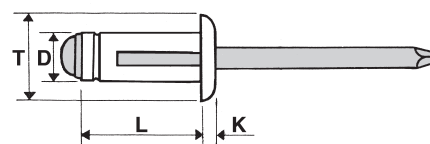
D +0,08/-0,15	L +1/-0,2	T max	K max	∅ foro/hole		CODICE code		
4,0	13,6	8,2	1,6	4,2 - 4,5		1 - 3 01ALSOF4014TT	800 N	500 N
	18,8					3 - 7 01ALSOF4019TT		
4,8	15,3	10,1	2,1	5,0 - 5,3		1 - 3 01ALSOF4815TT	1100 N	900 N
	20,5					3 - 9 01ALSOF4821TT		
	24,5					5 - 12 01ALSOF4825TT		

AL-SOF - TT



D +0,08/-0,15	L +1/-0,5	T max	K max	∅ foro/hole		CODICE code		
5,2	17,5	11,7	2,2	5,3		0,5 - 4,8 01ALSOF5218TTO	3200 N	2000 N
	22,2					4,8 - 9,5 01ALSOF5222TTO		
	25,4					7,9 - 12,7 01ALSOF5225TTO		
	28,6					11,1 - 15,9 01ALSOF5229TTO		
	31,8					14,3 - 19,1 01ALSOF5232TTO		

AL-SOF - TTO

La rondella in neoprene garantisce la tenuta stagna

Good seal thanks to neoprene washer

Mit Neopren Unterkopf Dichtung

Bonne étanchéité grâce à l'anneau en neoprene

Buen sellado gracias a arandela de neopreno

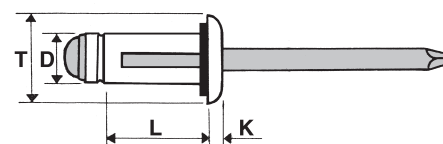

RIVETTI ALLUMINIO / ALLUMINIO TESTA TONDA

BLIND RIVETS ALUMINIUM / ALUMINIUM DOME HEAD

BLINDNIETE ALUMINIUM / ALUMINIUM FLACHKOPF

RIVETS ALUMINIUM / ALUMINIUM TÊTE PLATE

REMACHES ALUMINIO / ALUMINIO CABEZA ALOMADA

ALAL - TT

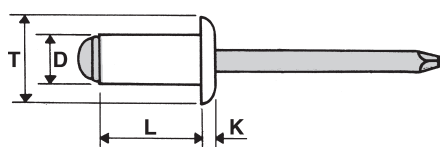

D	L	T	K	∅		CODICE		
+0,08/-0,15	+1/-0,2	max	max	foro/hole		code	min	min
3,2	6	6,7	1,3	3,3 - 3,4	1,5 - 3,5	01ALAL3206TT	670 N	500 N
	8				3,5 - 5,5	01ALAL3208TT		
	10				5,5 - 7	01ALAL3210TT		
	12				7 - 8,5	01ALAL3212TT		
	14				8,5 - 10,5	01ALAL3214TT		
	16				10,5 - 13	01ALAL3216TT		
4,0	6	8,4	1,7	4,1 - 4,2	1,5 - 3,5	01ALAL4006TT	1000 N	850 N
	8				3 - 5	01ALAL4008TT		
	10				5 - 6,5	01ALAL4010TT		
	12				6,5 - 8,5	01ALAL4012TT		
	14				8,5 - 10,5	01ALAL4014TT		
	16				10,5 - 12,5	01ALAL4016TT		
	18				12,5 - 14,5	01ALAL4018TT		
	20				14,5 - 16,5	01ALAL4020TT		
4,8	8	10,1	2,0	4,9 - 5,0	3 - 4,5	01ALAL4808TT	1400 N	1100 N
	10				4,5 - 6	01ALAL4810TT		
	12				6 - 8	01ALAL4812TT		
	14				8 - 10	01ALAL4814TT		
	16				10 - 12	01ALAL4816TT		
	18				12 - 14	01ALAL4818TT		
	20				14 - 16	01ALAL4820TT		
	25				15 - 20	01ALAL4825TT		
	30				20 - 25	01ALAL4830TT		

- A RICHIESTA DISPONIBILI CON TESTA SVASATA
- COUNTERSUNK HEAD AVAILABLE ON DEMAND
- SENKKOPF BLINDNIETE AUF ANFRAGE LIEFERBAR
- SUR DEMANDE DISPONIBLES AUSSI TÊTE FRAISÉE
- BAJO PEDIDO DISPONIBLES CON CABEZA AVELLANADA

RIVETTI MULTIFIX ALLUMINIO Mg. 2,5 / ACCIAIO ZINC. TESTA TONDA

MULTIFIX BLIND RIVETS ALUMINIUM Mg. 2,5 / STEEL ZINC DOME HEAD

MEHRBEREICHSBLINDNIETE ALUMINIUM Mg. 2,5 / STAHL VZ FLACHKOPF

RIVETS MULTIFIX ALUMINIUM Mg. 2,5 / ACIER ZINGUÉ TÊTE PLATE

REMACHES MULTIFIX ALUMINIO Mg. 2,5 / ACERO CINCADO CABEZA ALOMADA

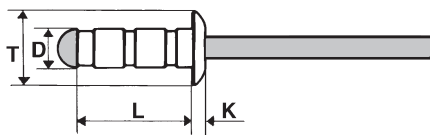
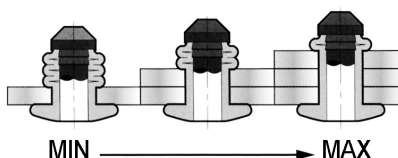
D +0,08/-0,15	L +1/-0,2	T max	K max	∅ foro/hole		CODICE code			
3,0	6	6,3	1,3	3,1 - 3,2	1 - 3	01MXAL3006TT	810 N	620 N	
	8				0,5 - 5	01MXAL3008TT			
	10				2 - 6,5	01MXAL3010TT			
	12				5 - 9,5	01MXAL3012TT			
3,2	6	6,7	1,3	3,3 - 3,4	0,5 - 4	01MXAL3206TT	980 N	680 N	
	8				1 - 4,8	01MXAL3208TT			
	9,5				2 - 6,5	01MXAL3210TT			
	11				4 - 7,9	01MXAL3211TT			
	12,5				5 - 9,5	01MXAL3212TT			
	14				6,5 - 11	01MXAL3214TT			
4,0	8	8,4	1,7	4,1 - 4,2	0,8 - 4,7	01MXAL4008TT	1600 N	1150 N	
	9,5				1,2 - 6,3	01MXAL4010TT			
	12,5				4 - 9,5	01MXAL4012TT			
	17				6,4 - 12,7	01MXAL4017TT			
	18				9,5 - 14,5	01MXAL4018TT			
4,8	10	10,1	2,0	4,9 - 5,0	0,3 - 5,5	01MXAL4810TT	2350 N	1500 N	
	11				1,3 - 6,5	01MXAL4811TT			
	12,5				3 - 7,5	01MXAL4813TT			
	15				4,8 - 11	01MXAL4815TT			
	17				6,4 - 12,7	01MXAL4817TT			
	20				10 - 15	01MXAL4820TT			
	24,8				12,7 - 19,8	01MXAL4825TT			
	27				17 - 23	01MXAL4827TT			
30	20 - 25	01MXAL4830TT							

- A RICHIESTA
- ON DEMAND
- AUF ANFRAGE LIEFERBAR
- SUR DEMANDE
- SI SE SOLICITA

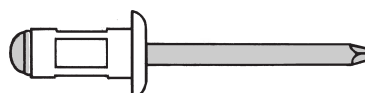

RIVETTI MULTIFIX ALLUMINIO Mg. 2,5 / ACCIAIO ZINC. TESTA SVASATA
MULTIFIX BLIND RIVETS ALUMINIUM Mg. 2,5 / STEEL ZINC COUNTERSUNK HEAD
MEHRBEREICHSBLINDNIETE ALUMINIUM Mg. 2,5 / STAHL VZ SENKKOPF
RIVETS MULTIFIX ALUMINIUM Mg. 2,5 / ACIER ZINGUÉ TÊTE FRAISÉE
REMACHES MULTIFIX ALUMINIO Mg. 2,5 / ACERO CINCADO CABEZA AVELLANADA

MX-AL - TS

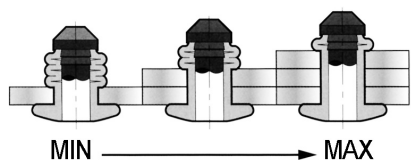
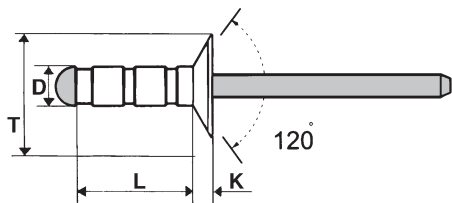

D +0,08/-0,15	L +1/-0,2	T max	K max	∅ foro/hole		CODICE code		
3,2	8	6,7	1,3	3,3 - 3,4		1,5 - 5	900 N	700 N
	9,5					2,5 - 6,5		
	12,5					5 - 9,5		
	14					6,5 - 11		
	16					8,5 - 13		
4,0	8	8,4	1,7	4,1 - 4,2		1,5 - 5	1300 N	1100 N
	9,5					2,5 - 6,5		
	12,5					4 - 9		
	14					5 - 10,5		
	17					8,5 - 13,5		
	18					9 - 14,5		
	20					11 - 16,5		
4,8	10	10,1	2,0	4,9 - 5,0		2,5 - 5	2350 N	1500 N
	12,5					3 - 7,5		
	15					5 - 10		
	17					7 - 12		
	20					10 - 15		
	22					12 - 18		
	24					14 - 20		
	27					17 - 23		
	30					20 - 25		

- A RICHIESTA
 - ON DEMAND
 - AUF ANFRAGE LIEFERBAR
 - SUR DEMANDE
 - SI SE SOLICITA

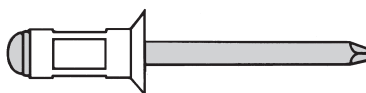







RIVETTI MULTIFIX ALL. Mg. 2,5 / ACCIAIO ZINC. TESTA LARGA - EXTRALARGA

MULTIFIX BLIND RIVETS ALUMINIUM Mg. 2,5 / STEEL ZINC LARGE - EXTRA LARGE HEAD

MEHRBEREICHSBLENDNIETE ALUMINIUM Mg. 2,5 / STAHL VZ GROßKOPF - EXTRA GROßKOPF

RIVETS MULTIFIX ALUMINIUM Mg. 2,5 / ACIER ZINGUÉ TÊTE LARGE - EXTRA LARGE



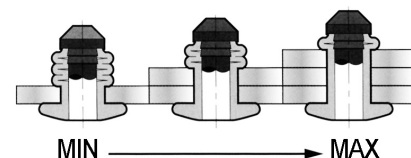
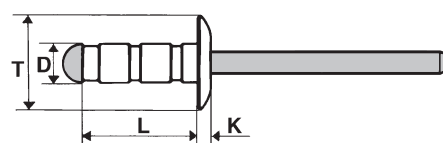

REMACHES MULTIFIX ALUMINIO Mg. 2,5 / ACERO CINCADO CABEZA GRANDE - EXTRA GRANDE

D +0,08/-0,15	L +1/-0,2	T	K max	∅ foro/hole		CODICE code		
3,2	8	8,8 - 10	1,3	3,3 - 4,0		01MXAL3208TL	980 N	680 N
	9,5					01MXAL3210TL		
	12,5					01MXAL3212TL		
	14					01MXAL3214TL		
	16					01MXAL3216TL		
4,0	9,5	11,9 - 12	1,7	4,1 - 4,2		01MXAL4010TL	1600 N	1150 N
	12,5					01MXAL4012TL		
	14					01MXAL4014TL		
	17					01MXAL4017TL		
	18					01MXAL4018TL		
	20					01MXAL4020TL		
4,8	10	13 - 14	2,0	4,9 - 5,0		01MXAL4810TL	2350 N	1500 N
	12,5					01MXAL4812TL		
	15					01MXAL4815TL		
	17					01MXAL4817TL		
	20					01MXAL4820TL		

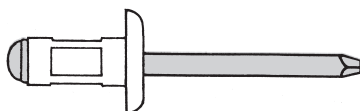
MX-AL-TL

- A RICHIESTA
- ON DEMAND
- AUF ANFRAGE LIEFERBAR
- SUR DEMANDE
- SI SE SOLICITA

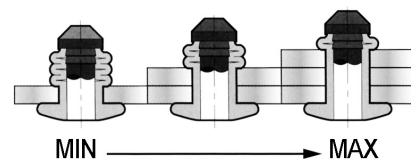
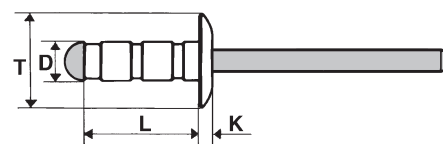

D +0,08/-0,15	L +1/-0,2	T	K max	∅ foro/hole		CODICE code		
4,8	10	15 - 16	2,0	4,9		01MXAL4810TXL	2350 N	1500 N
	12,5					01MXAL4812TXL		
	15					01MXAL4815TXL		
	17					01MXAL4817TXL		
	20					01MXAL4820TXL		
	24,8					01MXAL4824TXL		
	27					01MXAL4827TXL		

MX-AL-TXL

- A RICHIESTA
- ON DEMAND
- AUF ANFRAGE LIEFERBAR
- SUR DEMANDE
- SI SE SOLICITA

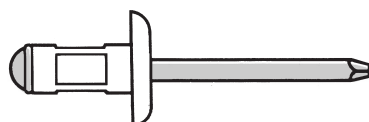

RIVETTI MULTIFIX ALLUMINIO Mg. 2,5 / INOX A2 TESTA TONDA
MULTIFIX BLIND RIVETS ALUMINIUM Mg. 2,5 / STAINLESS STEEL A2 DOME HEAD
MEHRBEREICHSBLINDNIETE ALUMINIUM Mg. 2,5 / EDELSTAHL A2 FLACHKOPF
RIVETS MULTIFIX ALUMINIUM Mg. 2,5 / INOX A2 TÊTE PLATE
REMACHES MULTIFIX ALUMINIO Mg. 2,5 / INOX A2 CABEZA ALOMADA

MX-ALX - TT

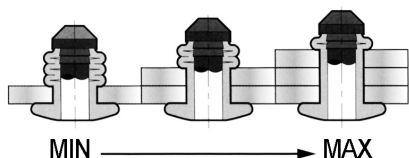
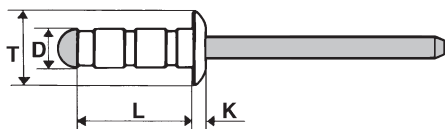

D +0,08/-0,15	L +1/-0,2	T max	K max	∅ foro/hole		CODICE code		
3,0	8	6,0	1,3	3,1	0,5 - 5	01MXALX3008TT	810 N	620 N
	9,5					01MXALX3010TT		
	12,5					01MXALX3013TT		
3,2	8	6,0	1,3	3,3	0,5 - 5	01MXALX3208TT	980 N	680 N
	9,5					01MXALX3210TT		
	12,5					01MXALX3213TT		
4,0	9,5	8,0	1,7	4,1	1 - 6	01MXALX4009TT	1600 N	1150 N
	12,5					01MXALX4012TT		
	16,9					01MXALX4016TT		
4,8	10	9,5	2,0	5,0	1 - 5	01MXALX4810TT	2350 N	1500 N
	12,5					01MXALX4813TT		
	15					01MXALX4815TT		
	16,9					01MXALX4816TT		
	20					01MXALX4820TT		
	24,8					01MXALX4824TT		

- A RICHIESTA DISPONIBILI CON TESTA SVASATA
 - COUNTERSUNK HEAD AVAILABLE ON DEMAND
 - SENKKOPF BLINDNIETE AUF ANFRAGE LIEFERBAR
 - SUR DEMANDE DISPONIBLES AUSSI TÊTE FRAISÉE
 - BAJO PEDIDO DISPONIBLES CON CABEZA AVELLANADA

- A RICHIESTA
 - ON DEMAND
 - AUF ANFRAGE LIEFERBAR
 - SUR DEMANDE
 - SI SE SOLICITA

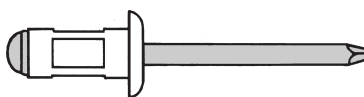







RIVETTI TENUTA STAGNA ALLUMINIO / ACCIAIO TESTA TONDA

SEALED BLIND RIVETS ALUMINIUM / STEEL DOME HEAD

BECHERBLINDNIETE ALUMINIUM / STAHL FLACHKOPF

RIVETS ÉTANCHES ALUMINIUM / ACIER TÊTE PLATE

REMACHES ESTANCOS ALUMINIO / ACERO CABEZA ALOMADA

D +0,08/-0,15	L +1/-0,2	T max	K max	∅ foro/hole		CODICE code		
3,2	6,5	6,7	1,3	3,3 - 3,4		01TSTAL3206TT	1450 N	1100 N
	8					01TSTAL3208TT		
	9,5					01TSTAL3210TT		
	11					01TSTAL3211TT		
	12,5					01TSTAL3212TT		
4,0	8	8,4	1,7	4,1 - 4,2		01TSTAL4008TT	2200 N	1600 N
	9,5					01TSTAL4010TT		
	11					01TSTAL4011TT		
	12,5					01TSTAL4012TT		
	14					01TSTAL4014TT		
4,8	8	10,1	2,0	4,9 - 5,0		01TSTAL4808TT	3100 N	2200 N
	9,5					01TSTAL4810TT		
	11					01TSTAL4811TT		
	12,5					01TSTAL4812TT		
	14					01TSTAL4814TT		
	16					01TSTAL4816TT		
	18					01TSTAL4818TT		
	20					01TSTAL4820TT		
25	01TSTAL4825TT							
6,4	12,5	13,4	2,7	6,5 - 6,6		01TSTAL6413TT	4900 N	3600 N
	16					01TSTAL6416TT		

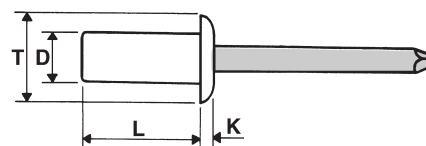





TST-AL-TT**RIVETTI TENUTA STAGNA ALLUMINIO / ACCIAIO TESTA SVASATA**

SEALED BLIND RIVETS ALUMINIUM / STEEL COUNTERSUNK HEAD

BECHERBLINDNIETE ALUMINIUM / STAHL SENKKOPF

RIVETS ÉTANCHES ALUMINIUM / ACIER TÊTE FRAISÉE

REMACHES ESTANCOS ALUMINIO / ACERO CABEZA AVELLANADA

D +0,08/-0,15	L +1/-0,2	T max	K max	∅ foro/hole		CODICE code		
3,2	6	6,7	1,3	3,3 - 3,4		01TSTAL3206TS	1450 N	1100 N
	7,5					01TSTAL3208TS		
	9					01TSTAL3209TS		
	10,5					01TSTAL3211TS		
	12					01TSTAL3212TS		
	13					01TSTAL3213TS		
4,0	9,5	8,4	1,7	4,1 - 4,2		01TSTAL4009TS	2200 N	1600 N
	11					01TSTAL4011TS		
	12,5					01TSTAL4012TS		
	14					01TSTAL4014TS		
4,8	9,5	10,1	2,0	4,9 - 5,0		01TSTAL4810TS	3100 N	2200 N
	11					01TSTAL4811TS		
	12,5					01TSTAL4812TS		
	14					01TSTAL4814TS		
	15,5					01TSTAL4816TS		
	17					01TSTAL4817TS		
	19					01TSTAL4819TS		
	24					01TSTAL4824TS		

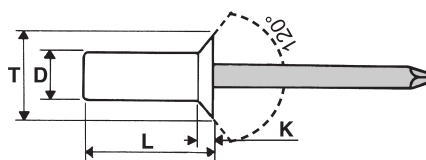
TST-AL-TS

RIVETTI TENUTA STAGNA ALLUMINIO / INOX A2 TESTA TONDA
SEALED BLIND RIVETS ALUMINIUM / STAINLESS STEEL A2 DOME HEAD
BECHERBLINDNIETE ALUMINIUM / EDELSTAHL A2 FLACHKOPF
RIVETS ÉTANCHES ALUMINIUM / INOX A2 TÊTE PLATE
REMACHES ESTANCOS ALUMINIO / INOX A2 CABEZA ALOMADA

TST-ALX - TT

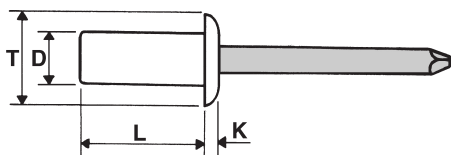

- A RICHIESTA DISPONIBILI CON TESTA SVASATA
- COUNTERSUNK HEAD AVAILABLE ON DEMAND
- SENKKOPF BLINDNIETE AUF ANFRAGE LIEFERBAR
- SUR DEMANDE DISPONIBLES AUSSI TÊTE FRAISÉE
- BAJO PEDIDO DISPONIBLES CON CABEZA AVELLANADA

D +0,08/-0,15	L +1/-0,2	T max	K max	∅ foro/hole		CODICE code		
3,2	6,5	6,7	1,3	3,3 - 3,4		01TSTALX3207TT	1245 N	1070 N
	8					01TSTALX3208TT		
	9,5					01TSTALX3210TT		
	11					01TSTALX3211TT		
	12,5					01TSTALX3213TT		
4,0	8	8,4	1,7	4,1 - 4,2		01TSTALX4008TT	2240 N	1700 N
	9,5					01TSTALX4010TT		
	11					01TSTALX4011TT		
	12,5					01TSTALX4013TT		
	15					01TSTALX4015TT		
4,8	8	10,1	2,0	4,9 - 5,0		01TSTALX4808TT	3070 N	2200 N
	9,5					01TSTALX4810TT		
	11					01TSTALX4811TT		
	12,5					01TSTALX4813TT		
	14					01TSTALX4814TT		
	16					01TSTALX4816TT		
	18					01TSTALX4818TT		
	21					01TSTALX4821TT		
	25					01TSTALX4825TT		
	25					01TSTALX4825TT		

RIVETTI RULLATI ALLUMINIO / ACCIAIO ZINCATO TESTA TONDA
GROOVED RIVETS ALUMINIUM / STEEL ZINC PLATED DOME HEAD
GERILLTE BLINDNIETE ALUMINIUM / STAHL VZ FLACHKOPF
RIVETS CANNELÉS ALUMINIUM / ACIER ZINGUÉ TÊTE PLATE
REMACHES RANURADOS ALUMINIO / ACERO CINCADO CABEZA ALOMADA

AL-RUL - TT

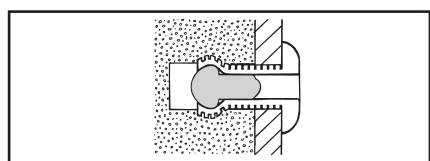
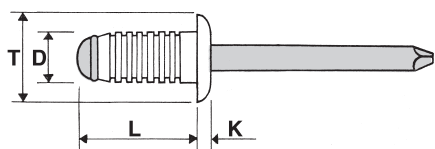

D +0,08/-0,15	L +1/-0,2	T max	K max	∅ foro/hole		CODICE code		
3,2	10	6,7	1,3	3,4 - 3,5		01ALRUL3210TT	930 N	525 N
						01ALRUL3214TT		
4,0	10	8,4	1,7	4,3 - 4,4		01ALRUL4008TT	1410 N	885 N
						01ALRUL4010TT		
						01ALRUL4012TT		
						01ALRUL4016TT		
						01ALRUL4016TT		
4,8	10	10,1	2,0	5,1 - 5,2		01ALRUL4808TT	1575 N	1185 N
						01ALRUL4810TT		
						01ALRUL4811TT		
						01ALRUL4812TT		
						01ALRUL4814TT		
						01ALRUL4816TT		
						01ALRUL4818TT		
						01ALRUL4820TT		
						01ALRUL4825TT		
						01ALRUL4825TT		
						01ALRUL4830TT		
						01ALRUL4830TT		

RIVETTI STRUTTURALI ALLUMINIO / ALLUMINIO TESTA TONDA

STRUCTURAL BLIND RIVETS ALUMINIUM / ALUMINIUM DOME HEAD

HOCHFESTE BLINDNIETE ALUMINIUM / ALUMINIUM FLACHKOPF

RIVETS DE STRUCTURE ALUMINIUM / ALUMINIUM TÊTE PLATE

REMACHES ESTRUCTUALES ALUMINIO / ALUMINIO CABEZA ALOMADA

- Elevata resistenza alle vibrazioni e buona tenuta ermetica
- *High resistance to vibrations and good seal*
- *Hohe Rüttelfestigkeit und gute Dichtigkeit*
- *Haute résistance aux vibrations et excellente tenue hermétique*
- *Excelente resistencia a las vibraciones y sellado*

D	L	T	K	F	∅		CODICE		
+0,08/-0,15	+1/-0,2	max	max	max	foro/hole		code		
4,8	10	10,2	2,3	21,4	4,9 - 5,2		01MFX4810TTAL		2000
	14			24,8			01MFX4814TTAL		N
6,4	14	13,5	3,0	30,0	6,6 - 6,9		01MFX6414TTAL		3690
	20			35,6			01MFX6420TTAL		N

MFX-TT AL

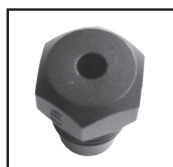
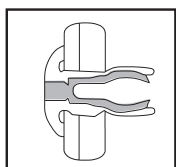
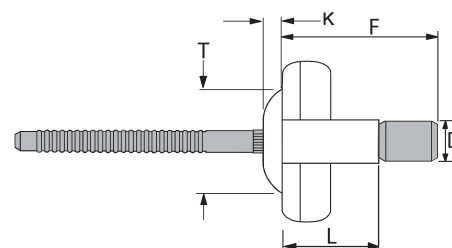

- DA UTILIZZARE CON UGELLO STANDARD
- TO BE USED WITH STANDARD NOSE PIECE
- KEIN SONDERMUNDSTÜCK NOTWENDIG
- À UTILISER AVEC BUSE STANDARD
- PARA SER USADO CON EL CABEZAL STANDARD

RIVETTI STRUTTURALI ALLUMINIO / ALLUMINIO TESTA SVASATA

STRUCTURAL BLIND RIVETS ALUMINIUM / ALUMINIUM COUNTERSUNK HEAD

HOCHFESTE BLINDNIETE ALUMINIUM / ALUMINIUM SENKKOPF

RIVETS DE STRUCTURE ALUMINIUM / ALUMINIUM TÊTE FRAISÉE

REMACHES ESTRUCTUALES ALUMINIO / ALUMINIO CABEZA AVELLANADA

- Elevata resistenza alle vibrazioni e buona tenuta ermetica
- *High resistance to vibrations and good seal*
- *Hohe Rüttelfestigkeit und gute Dichtigkeit*
- *Haute résistance aux vibrations et excellente tenue hermétique*
- *Excelente resistencia a las vibraciones y sellado*

D	L	T	K	F	∅		CODICE		
					foro/hole		code		
4,8	12,7	8,5	2,2	20	4,9 - 5,1		01MFX4813TSAL		2000
	15,9			26,2			01MFX4816TSAL		N
6,4	17,2	10,1	2,4	27,2	6,6 - 7,0		01MFX6417TSAL		3690
									N

MFX-TS AL

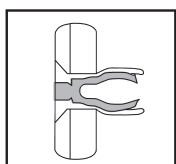
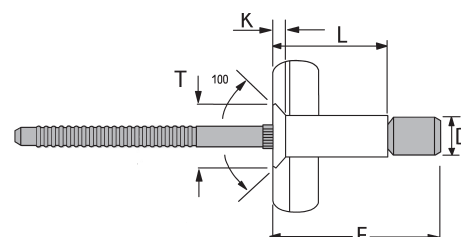

- DA UTILIZZARE CON UGELLO STANDARD
- TO BE USED WITH STANDARD NOSE PIECE
- KEIN SONDERMUNDSTÜCK NOTWENDIG
- À UTILISER AVEC BUSE STANDARD
- PARA SER USADO CON EL CABEZAL STANDARD

RIVETTI ACCIAIO ZINCATO / ACCIAIO ZINCATO TESTA TONDA

BLIND RIVETS STEEL ZINC PLATED / STEEL ZINC PLATED DOME HEAD

BLINDNIETE STAHL VZ / STAHL VZ FLACHKOPF

RIVETS ACIER ZINGUÉ / ACIER ZINGUÉ TÊTE PLATE

REMACHES ACERO CINCADO / ACERO CINCADO CABEZA ALOMADA

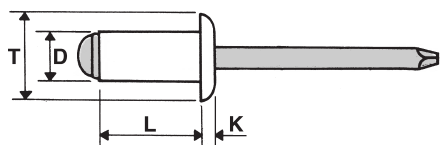
AOZ - TT

D	L	T	K	∅		CODICE		
+0,08/-0,15	+1/-0,2	max	max	foro/hole		code	min	min
3,0	5	6,3	1,3	3,1 - 3,2	0,5 - 1,5	01AOZ3005TT	1100 N	950 N
	6				0,5 - 3	01AOZ3006TT		
	7				3 - 4	01AOZ3007TT		
	8				4 - 5	01AOZ3008TT		
	9				5 - 6	01AOZ3009TT		
	10				6 - 7	01AOZ3010TT		
	11				7 - 8	01AOZ3011TT		
	12				8 - 9	01AOZ3012TT		
	13				9 - 10	01AOZ3013TT		
	14				10 - 11	01AOZ3014TT		
3,2	6	6,7	1,3	3,3 - 3,4	0,5 - 3	01AOZ3206TT	1200 N	1100 N
	7				3 - 4	01AOZ3207TT		
	8				3 - 5	01AOZ3208TT		
	9				5 - 6	01AOZ3209TT		
	10				5 - 6,5	01AOZ3210TT		
	11				7 - 8	01AOZ3211TT		
	12				6,5 - 9	01AOZ3212TT		
	14				9 - 11	01AOZ3214TT		
	16				9 - 12	01AOZ3216TT		
	4,0				6	8,4		
7		2 - 3,5	01AOZ4007TT					
8		2,5 - 5	01AOZ4008TT					
9		4 - 5,5	01AOZ4009TT					
10		5 - 6,5	01AOZ4010TT					
11		6 - 7,5	01AOZ4011TT					
12		6,8 - 8,5	01AOZ4012TT					
14		8,5 - 10,5	01AOZ4014TT					
16		10,5 - 12,5	01AOZ4016TT					
18		12,5 - 14,5	01AOZ4018TT					
20		14 - 16,5	01AOZ4020TT					
24		16 - 20,5	01AOZ4024TT					
30		16,5 - 25	01AOZ4030TT					
4,8		6	10,1	2,0	4,9 - 5,0		0,5 - 2	01AOZ4806TT
	7	1,5 - 3				01AOZ4807TT		
	8	1,6 - 4				01AOZ4808TT		
	9	3,5 - 5				01AOZ4809TT		
	10	4 - 6				01AOZ4810TT		
	11	5,5 - 7				01AOZ4811TT		
	12	6 - 8				01AOZ4812TT		
	14	8 - 9,5				01AOZ4814TT		
	16	9,5 - 12				01AOZ4816TT		
	18	11,5 - 14				01AOZ4818TT		
	20	14 - 16				01AOZ4820TT		
	24	16 - 20				01AOZ4824TT		
	26	17,5 - 22				01AOZ4826TT		
	30	20 - 25				01AOZ4830TT		
5	10	10,5	2,1	5,1 - 5,2	4 - 6	01AOZ5010TT	4000 N	3100 N
	12				6 - 8	01AOZ5012TT		
	14				8 - 9,5	01AOZ5014TT		
6,0	10	12,6	2,5	6,1 - 6,2	3 - 4	01AOZ6010TT	4800 N	4300 N
	12				3,5 - 7	01AOZ6012TT		
	15				6,5 - 10	01AOZ6015TT		
	18				10 - 13	01AOZ6018TT		
	22				12,5 - 17	01AOZ6022TT		
	30				16,5 - 21	01AOZ6026TT		
30	20,5 - 25	01AOZ6030TT						
6,4	10	13,4	2,7	6,5 - 6,6	2 - 4	01AOZ6410TT	5700 N	4900 N
	12				3,5 - 7	01AOZ6412TT		
	15				6,5 - 10	01AOZ6415TT		
	18				9,5 - 13	01AOZ6418TT		
	22				13 - 16	01AOZ6422TT		
	26				16,5 - 21	01AOZ6426TT		
	30				16 - 24	01AOZ6430TT		







RIVETTI ACCIAIO ZINCATO / ACCIAIO ZINCATO TESTA SVASATA

BLIND RIVETS STEEL ZINC PLATED / STEEL ZINC PLATED COUNTERSUNK HEAD

BLINDNIETE STAHL VZ / STAHL VZ SENKKOPF

RIVETS ACIER ZINGUÉ / ACIER ZINGUÉ TÊTE FRAISÉE

REMACHES ACERO CINCADO / ACERO CINCADO CABEZA AVELLANADA

D +0,08/-0,15	L +1/-0,2	T max	K max	∅ foro/hole		CODICE code			
3,0	6	6,3	1,3	3,1 - 3,2		1,5 - 3	01AOZ3006TS	1100 N	950 N
	8					3 - 5	01AOZ3008TS		
	10					5 - 7	01AOZ3010TS		
	12					7 - 9	01AOZ3012TS		
3,2	6	6,7	1,3	3,3 - 3,4		1,5 - 3	01AOZ3206TS	1200 N	1100 N
	8					3 - 5	01AOZ3208TS		
	10					5 - 7	01AOZ3210TS		
	12					7 - 9	01AOZ3212TS		
	14					8 - 11	01AOZ3214TS		
4,0	6	8,4	1,7	4,1 - 4,2		1,5 - 2,5	01AOZ4006TS	2200 N	1700 N
	8					2,5 - 4,5	01AOZ4008TS		
	10					4,5 - 6,5	01AOZ4010TS		
	12					6,5 - 8,5	01AOZ4012TS		
	14					8,5 - 10,5	01AOZ4014TS		
	16					10,5 - 12,5	01AOZ4016TS		
4,8	8	10,1	2,0	4,9 - 5,0		1,5 - 4	01AOZ4808TS	3100 N	2900 N
	10					4 - 6	01AOZ4810TS		
	12					5,5 - 7,5	01AOZ4812TS		
	14					7 - 9	01AOZ4814TS		
	16					9 - 11,5	01AOZ4816TS		
	20					11 - 15	01AOZ4820TS		
	22					15 - 17,5	01AOZ4822TS		

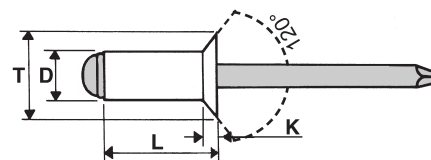



AOZ - TS**RIVETTI PER MATERIE PLASTICHE ACCIAIO ZINC. / ACCIAIO ZINC. T. TONDA**

BLIND RIVETS FOR PLASTIC STEEL ZINC PLATED / STEEL ZINC PLATED DOME HEAD

LASCHENBLINDNIETE STAHL VZ / STAHL VZ FLACHKOPF

RIVETS POUR PLASTIQUE ACIER ZINGUÉ / ACIER ZINGUÉ TÊTE PLATE

REMACHES PARA MATERIAS PLASTICAS ACERO CINCADO / ACERO CINCADO CABEZA ALOMADA

D +0,1/-0,3	L +0,5/-0,5	T +0,3/-0,3	K +0,2/-0,2	∅ foro/hole		CODICE code			
4,82	17,2	9,8	1,8	5,0 - 5,2		1 - 6,4	01AOZSOF4817TT	2500 N	2000 N
	19,5					3 - 8,5	01AOZSOF4820TT		

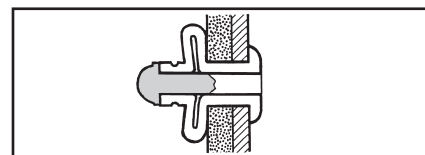
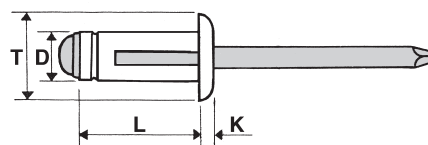
AOZSOF - TT

RIVETTI MULTIFIX ACCIAIO ZINCATO / ACCIAIO ZINCATO TESTA TONDA

MULTIFIX BLIND RIVETS STEEL ZINC PLATED / STEEL ZINC PLATED DOME HEAD

MEHRBEREICHBSBLINDNIETE STAHL VZ / STAHL VZ FLACHKOPF

RIVETS MULTIFIX ACIER ZINGUÉ / ACIER ZINGUÉ TÊTE PLATE

REMACHES MULTIFIX ACERO CINCADO / ACERO CINCADO CABEZA ALOMADA

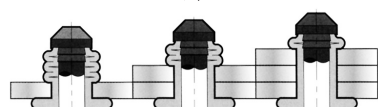
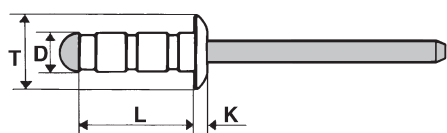
MX-AOZ - TT

MIN → MAX

- A RICHIESTA DISPONIBILI CON TESTA SVASATA
- COUNTERSUNK HEAD AVAILABLE ON DEMAND
- SENKKOPF BLINDNIETE AUF ANFRAGE LIEFERBAR
- SUR DEMANDE DISPONIBLES AUSSI TÊTE FRAISÉE
- BAJO PEDIDO DISPONIBLES CON CABEZA AVELLANADA

D	L	T	K	∅		CODICE		
+0,08/-0,15	+1/-0,2	max	max	foro/hole		code		
3,2	7	6,7	1,3	3,3 - 3,4	1 - 3,5	01MXAOZ3207TT	1300 N	1200 N
	9				2 - 5,5	01MXAOZ3209TT		
	11				4 - 7	01MXAOZ3211TT		
4,0	10,8	8,4	1,7	4,1 - 4,2	1,5 - 4,5	01MXAOZ4011TT	2800 N	2400 N
	12,5				3 - 6,5	01MXAOZ4013TT		
	15				5,5 - 8,5	01MXAOZ4015TT		
4,8	10,2	10,1	2,0	4,9 - 5,0	1,5 - 4,5	01MXAOZ4810TT	3800 N	3600 N
	12,7				3,5 - 7,5	01MXAOZ4813TT		
	13,5				6 - 8,5	01MXAOZ4814TT		
	17,5				8 - 12	01MXAOZ4818TT		

RIVETTI TENUTA STAGNA ACCIAIO ZINC. / ACCIAIO ZINC. TESTA TONDA

SEALED BLIND RIVETS STEEL ZINC PLATED / STEEL ZINC PLATED DOME HEAD

BECHERBLINDNIETE STAHL VZ / STAHL VZ FLACHKOPF

RIVETS ÉTANCHES ACIER ZINGUÉ / ACIER ZINGUÉ TÊTE PLATE

REMACHES ESTANCOS ACERO CINCADO / ACERO CINCADO CABEZA ALOMADA

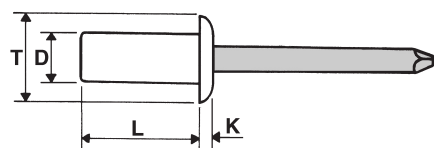
TST-AOZ - TT

- A RICHIESTA DISPONIBILI CON TESTA SVASATA
- COUNTERSUNK HEAD AVAILABLE ON DEMAND
- SENKKOPF BLINDNIETE AUF ANFRAGE LIEFERBAR
- SUR DEMANDE DISPONIBLES AUSSI TÊTE FRAISÉE
- BAJO PEDIDO DISPONIBLES CON CABEZA AVELLANADA

D	L	T	K	∅		CODICE		
+0,08/-0,15	+1/-0,2	max	max	foro/hole		code		
3,2	6	6,7	1,3	3,3 - 3,4	0,5 - 1,5	01TSTAOZ3206TT	1300 N	1150 N
	8				1,5 - 3	01TSTAOZ3208TT		
	9,5				3 - 5	01TSTAOZ3209TT		
	12				5 - 6,5	01TSTAOZ3212TT		
4,0	6	8,4	1,7	4,1 - 4,2	0,5 - 1,5	01TSTAOZ4006TT	1550 N	1700 N
	8				1,5 - 3	01TSTAOZ4008TT		
	10				3 - 5	01TSTAOZ4010TT		
	12				5 - 6,5	01TSTAOZ4012TT		
	15				6,5 - 10,5	01TSTAOZ4015TT		
4,8	8	10,1	2,0	4,9 - 5,0	1 - 3	01TSTAOZ4808TT	2800 N	2400 N
	10				3 - 4,5	01TSTAOZ4810TT		
	12				4,5 - 6	01TSTAOZ4812TT		
	16				6 - 10,5	01TSTAOZ4816TT		

RIVETTI STRUTTURALI ACCIAIO ZINC. / ACCIAIO ZINC. TESTA TONDA

STRUCTURAL BLIND RIVETS STEEL ZINC PLATED / STEEL ZINC PLATED DOME HEAD
HOCHFESTE BLINDNIETE STAHL VZ / STAHL VZ FLACHKOPF
RIVETS DE STRUCTURE ACIER ZINGUÉ / ACIER ZINGUÉ TÊTE PLATE
REMACHES ESTRUCTUALES ACERO CINCADO / ACERO CINCADO CABEZA ALOMADA

- Elevata resistenza alle vibrazioni e buona tenuta ermetica
- *High resistance to vibrations and good seal*
- *Hohe Rüttelfestigkeit und gute Dichtigkeit*
- *Haute résistance aux vibrations et excellente tenue hermétique*
- *Excelente resistencia a las vibraciones y sellado*

D	L	T	K	F	∅		CODICE			
+0,08/-0,15	+1/-0,2	max	max	max	foro/hole		code			
4,8	10	10,2	2,3	18,3	4,9 - 5,2		01MFX4810TT		4440	5780
	14			25,5			01MFX4814TT		N	N
6,4	14	13,5	3,0	30,0	6,6 - 7,0		01MFX6414TT		8220	11000
	20			36,2			01MFX6420TT		N	N
7,8	21	16,4	3,8	39,0	8,0 - 8,3		01MFX7821TT		8300	13700
									N	N

MFX - TT

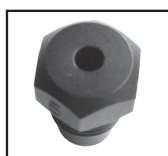
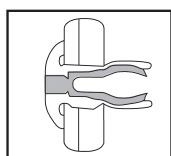
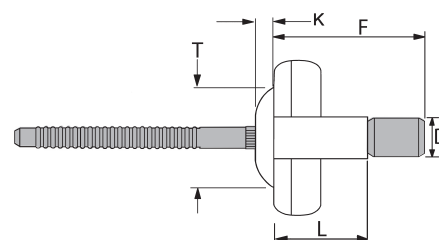

- DA UTILIZZARE CON UGELLO STANDARD
- TO BE USED WITH STANDARD NOSE PIECE
- KEIN SONDERMUNDSTÜCK NOTWENDIG
- À UTILISER AVEC BUSE STANDARD
- PARA SER USADO CON EL CABEZAL STANDARD

RIVETTI STRUTTURALI ACCIAIO ZINC. / ACCIAIO ZINC. TESTA SVASATA

STRUCTURAL BLIND RIVETS STEEL ZINC PLATED / STEEL ZINC PLATED COUNTERSUNK HEAD
HOCHFESTE BLINDNIETE STAHL VZ / STAHL VZ SENKKOPF
RIVETS DE STRUCTURE ACIER ZINGUÉ / ACIER ZINGUÉ TÊTE FRAISÉE
REMACHES ESTRUCTUALES ACERO CINCADO / ACERO CINCADO CABEZA AVELLANADA

- Elevata resistenza alle vibrazioni e buona tenuta ermetica
- *High resistance to vibrations and good seal*
- *Hohe Rüttelfestigkeit und gute Dichtigkeit*
- *Haute résistance aux vibrations et excellente tenue hermétique*
- *Excelente resistencia a las vibraciones y sellado*

D	L	T	K	F	∅		CODICE			
					foro/hole		code			
4,8	13	8,5	2,2	20,0	4,9 - 5,1		01MFX4813TS		4100	5780
	16			26,2			01MFX4816TS		N	N
6,4	17	10,2	2,4	27,0	6,6 - 7,0		01MFX6417TS		8240	10690
	22			33,0			01MFX6422TS		N	N

MFX - TS

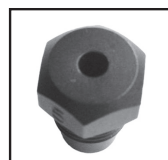
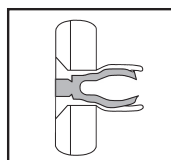
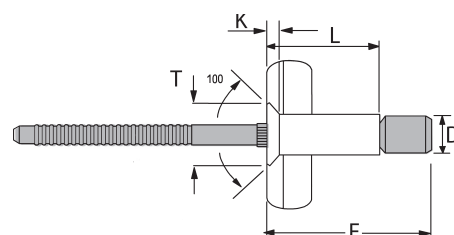

- DA UTILIZZARE CON UGELLO STANDARD
- TO BE USED WITH STANDARD NOSE PIECE
- KEIN SONDERMUNDSTÜCK NOTWENDIG
- À UTILISER AVEC BUSE STANDARD
- PARA SER USADO CON EL CABEZAL STANDARD

RIVETTI STRUTTURALI ACCIAIO ZINC. / ACCIAIO ZINC. TESTA TONDA
STRUCTURAL BLIND RIVETS STEEL ZINC PLATED / STEEL ZINC PLATED DOME HEAD
HOCHFESTE BLINDNIETE STAHL VZ / STAHL VZ FLACHKOPF
RIVETS DE STRUCTURE ACIER ZINGUÉ / ACIER ZINGUÉ TÊTE PLATE
REMACHES ESTRUCTUALES ACERO CINCADO / ACERO CINCADO CABEZA ALOMADA

- La controtesta più larga garantisce maggiore tenuta e non deforma i materiali a lastra sottile. E' resistente all'acqua ed alle vibrazioni.
- *For thin sheet applications. Good resistance to vibrations and good seal*
- *Die Schließkopfformung dient für eine höhere Festigkeit und verformt nicht die ganz dünne Bleche. Hohe Rüttelfestigkeit und gute Dichtigkeit*
- *Pour applications sur tôle fine. Bonne résistance aux vibrations et bonne tenue.*
- *Para aplicación en chapa de poco grosor. Buena resistencia a las vibraciones y buen sellado.*

MBX - TT

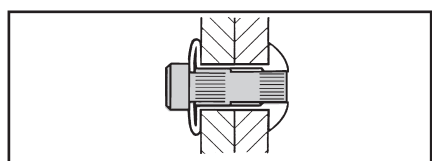
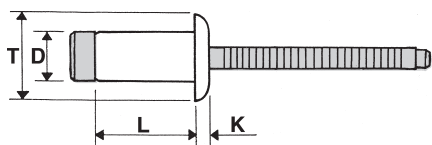

D +0,08/-0,15	L +1/-0,2	T max	K max	∅ foro/hole		CODICE code			
3,2	7	6,7	1,3	3,3 - 3,4		1 - 3	01MBX3207TT	1300 N	1200 N
	9					3 - 5	01MBX3209TT		
	11					5 - 7	01MBX3211TT		
4,0	7,5	8,4	1,7	4,1 - 4,2		1 - 3	01MBX4008TT	2200 N	2000 N
	9,5					3 - 5	01MBX4010TT		
	12,5					5 - 7	01MBX4012TT		
4,8	10	10,1	2,0	4,9 - 5,0		1,5 - 3,5	01MBX4810TT	3300 N	3100 N
	12					3,5 - 6	01MBX4812TT		
	14					6 - 8,5	01MBX4814TT		
6,0	10	12,6	2,5	6,1 - 6,2		1,5 - 4	01MBX6010TT	5400 N	4200 N
	13					3 - 6	01MBX6013TT		
	16					6 - 9	01MBX6016TT		
	19					9 - 12	01MBX6019TT		
6,4	9	13,4	2,7	6,5 - 6,6		1,5 - 3,5	01MBX6409TT	6600 N	7000 N
	10					2,8 - 4,8	01MBX6410TT		
	11					3,4 - 5,4	01MBX6411TT		
	12					4,8 - 6,8	01MBX6412TT		
	14					6,8 - 8,8	01MBX6414TT		
	16					8,8 - 10,8	01MBX6416TT		
	18					10,8 - 12,8	01MBX6418TT		
20	12,8 - 14,8	01MBX6420TT							
7,8	13,5	16,4	4,1	8 - 8,3		4 - 7	01MBX7814TT	9100 N	13800 N
	16,5					7 - 10	01MBX7817TT		
	19,5					10 - 13	01MBX7820TT		
	22,5					13 - 16	01MBX7823TT		
	25,5					16 - 19	01MBX7826TT		
	28,5					19 - 22	01MBX7829TT		
	31,5					22 - 25	01MBX7832TT		



RIVETTI INOX A2 / INOX A2 TESTA TONDA

BLIND RIVETS STAINLESS STEEL A2 / STAINLESS STEEL A2 DOME HEAD

BLINDNIETE EDELSTAHL A2 / EDELSTAHL A2 FLACHKOPF

RIVETS INOX A2 / INOX A2 TÊTE PLATE

REMACHES INOX A2 / INOX A2 CABEZA ALOMADA

D +0,08/-0,15	L +1/-0,2	T max	K max	∅ foro/hole		CODICE code		
2,4	4	5,0	1,0	2,5 - 2,6	0,5 - 2	011XA22404TT	1500 N	1000 N
	6				2 - 4	011XA22406TT		
	8				4 - 6	011XA22408TT		
3,0	6	6,3	1,3	3,1 - 3,2	1,5 - 2,5	011XA23006TT	2200 N	1800 N
	8				2,5 - 4,5	011XA23008TT		
	10				4,5 - 6,5	011XA23010TT		
	12				6,5 - 8,5	011XA23012TT		
	16				8,2 - 12,5	011XA23016TT		
3,2	6	6,7	1,3	3,3 - 3,4	1,5 - 2,5	011XA23206TT	2500 N	1900 N
	8				2,5 - 4,5	011XA23208TT		
	10				4,5 - 6,5	011XA23210TT		
	12				6,5 - 8,5	011XA23212TT		
	14				8,5 - 10,5	011XA23214TT		
	16				10,5 - 12,5	011XA23216TT		
	18				12 - 14	011XA23218TT		
4,0	6	8,4	1,7	4,1 - 4,2	1 - 2	011XA24006TT	3500 N	2700 N
	8				2 - 4	011XA24008TT		
	10				4 - 6	011XA24010TT		
	12				6 - 8	011XA24012TT		
	14				8 - 10	011XA24014TT		
	16				10 - 12,5	011XA24016TT		
	18				12 - 14	011XA24018TT		
	20				14 - 16	011XA24020TT		
	25				16 - 21	011XA24025TT		
4,8	6	10,1	2,0	4,9 - 5,0	1 - 2	011XA24806TT	5000 N	4800 N
	8				1,5 - 3	011XA24808TT		
	10				3 - 5	011XA24810TT		
	12				5 - 7	011XA24812TT		
	14				7 - 9	011XA24814TT		
	16				9 - 11	011XA24816TT		
	18				11 - 13	011XA24818TT		
	20				13 - 15	011XA24820TT		
	22				15 - 17	011XA24822TT		
	24				16 - 18	011XA24824TT		
	25				17 - 20	011XA24825TT		
	26				18 - 20	011XA24826TT		
	30				20 - 25	011XA24830TT		
35	25 - 30	011XA24835TT						
40	30 - 34	011XA24840TT						
6,0	8	12,6	2,5	6,1 - 6,2	2 - 4	011XA26008TT	5000 N	4800 N
	10				4 - 6	011XA26010TT		
	12				6 - 8	011XA26012TT		
	14				7 - 9,5	011XA26014TT		
	16				8 - 11	011XA26016TT		
	18				9 - 13	011XA26018TT		
	20				11 - 15	011XA26020TT		
	25				15 - 20	011XA26025TT		
	30				20 - 24	011XA26030TT		
	35				24 - 29	011XA26035TT		
	40				29 - 34	011XA26040TT		
6,4	10	13,4	2,7	6,5 - 6,6	2 - 4	011XA26410TT	8000 N	6000 N
	12				4 - 6	011XA26412TT		
	14				6 - 8	011XA26414TT		
	16				7 - 10	011XA26416TT		
	18				9 - 13	011XA26418TT		
	20				13 - 16	011XA26420TT		
	22				14 - 17	011XA26422TT		
	25				15 - 19	011XA26425TT		
	30				19 - 23	011XA26430TT		
	35				23 - 28	011XA26435TT		
	40				28 - 33	011XA26440TT		

IX-A2 - TT

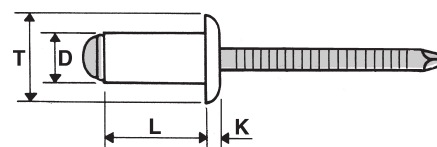

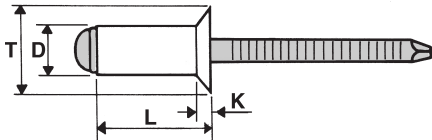
RIVETTI INOX A2 / INOX A2 TESTA SVASATA*BLIND RIVETS STAINLESS STEEL A2 / STAINLESS STEEL A2 COUNTERSUNK HEAD**BLINDNIETE EDELSTAHL A2 / EDELSTAHL A2 SENKKOPF**RIVETS INOX A2 / INOX A2 TÊTE FRAISÉE**REMACHES INOX A2 / INOX A2 CABEZA AVELLANADA***IX-A2 - TS**

D +0,08/-0,15	L +1/-0,2	T max	K max	ø foro/hole		CODICE code		
							min	min
3,0	6	6,3	1,3	3,1 - 3,2	1,5 - 3	01IXA23006TS	2200 N	1800 N
	8				3 - 5	01IXA23008TS		
	10				5 - 6,5	01IXA23010TS		
	12				6,5 - 8,5	01IXA23012TS		
3,2	6	6,7	1,3	3,3 - 3,4	1,5 - 2,5	01IXA23206TS	2500 N	1900 N
	8				2,5 - 4,5	01IXA23208TS		
	10				4,5 - 6,5	01IXA23210TS		
	12				6,5 - 8,5	01IXA23212TS		
4,0	8	8,4	1,7	4,1 - 4,2	2 - 4	01IXA24008TS	3500 N	2700 N
	10				4 - 6	01IXA24010TS		
	12				6 - 8	01IXA24012TS		
	14				8 - 10	01IXA24014TS		
	16				10 - 12	01IXA24016TS		
	18				12 - 14	01IXA24018TS		
	20				14 - 16	01IXA24020TS		
4,8	8	10,1	2,0	4,9 - 5,0	1,5 - 3	01IXA24808TS	5000 N	4000 N
	10				3 - 5	01IXA24810TS		
	12				5 - 7	01IXA24812TS		
	14				7 - 9	01IXA24814TS		
	16				9 - 11	01IXA24816TS		
	18				11 - 13	01IXA24818TS		
	20				13 - 15	01IXA24820TS		
	25				15 - 17	01IXA24825TS		
	30				17 - 19	01IXA24830TS		







RIVETTI INOX A2 / INOX A2 TESTA LARGA - EXTRA LARGA

BLIND RIVETS STAINLESS STEEL A2 / STAINLESS STEEL A2 LARGE - EXTRA LARGE HEAD

BLINDNIETE EDELSTAHL A2 / EDELSTAHL A2 GROßKOPF - EXTRA GROßKOPF





RIVETS INOX A2 / INOX A2 TÊTE LARGE - EXTRA LARGE

REMACHES INOX A2 / INOX A2 CABEZA GRANDE - EXTRA GRANDE

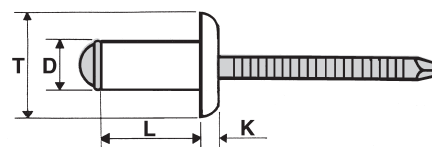
D +0,08/-0,15	L +1/-0,2	T	K max	∅ foro/hole		CODICE code			
3,2	6	9,5	1,3	3,3 - 3,4		1,5 - 2,5	2500 N	1900 N	
	8					2,5 - 4,5			01IXA23208TL
	10					4,5 - 6,5			01IXA23210TL
	12					6,5 - 8,5			01IXA23212TL
	14					8,5 - 12			01IXA23214TL
4,0	6	12,0	1,7	4,1 - 4,2		1 - 2	3500 N	2700 N	
	8					2 - 4			01IXA24008TL
	10					4 - 6			01IXA24010TL
	12					6 - 8			01IXA24012TL
	14					8 - 10			01IXA24014TL
	16					10 - 12			01IXA24016TL
4,8	8	14,0	2,0	4,9 - 5,0		1,5 - 3	5000 N	4000 N	
	10					3 - 5			01IXA24810TL
	12					5 - 7			01IXA24812TL
	14					7 - 9			01IXA24814TL
	16					9 - 11			01IXA24816TL
	18					11 - 13			01IXA24818TL
	20					13 - 15			01IXA24820TL

IX-A2 - TL



D +0,08/-0,15	L +1/-0,2	T	K max	∅ foro/hole		CODICE code			
4,8	8	16,0	2,0	4,9 - 5,0		1,5 - 3	5000 N	4000 N	
	10					3 - 5			01IXA24810TXL
	12					5 - 7			01IXA24812TXL
	14					7 - 9			01IXA24814TXL
	16					9 - 11			01IXA24816TXL
	18					11 - 13			01IXA24818TXL
	20					13 - 15			01IXA24820TXL
	22					16 - 18			01IXA24822TXL
	25					18 - 20			01IXA24825TXL
	30					20 - 25			01IXA24830TXL

IX-A2 - TXL

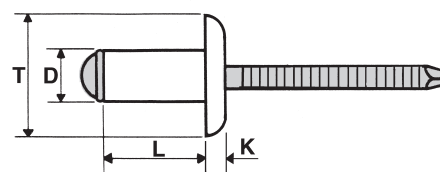

RIVETTI INOX A4 / INOX A4 TESTA TONDA

BLIND RIVETS STAINLESS STEEL A4 / STAINLESS STEEL A4 DOME HEAD

BLINDNIETE EDELSTAHL A4 / EDELSTAHL A4 FLACHKOPF

RIVETS INOX A4 / INOX A4 TÊTE PLATE

REMACHES INOX A4 / INOX A4 CABEZA ALOMADA

IX-A4 - TT

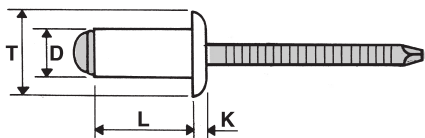

D +0,08/-0,15	L	T max	K max	∅ foro/hole		CODICE code		
3,0	6	6,3	1,3	3,1 - 3,2	1,5 - 2,5	01IXA43006TT	2200 N	1800 N
	8				2,5 - 4,5	01IXA43008TT		
	10				4,5 - 6,5	01IXA43010TT		
	12				6,5 - 8,5	01IXA43012TT		
	14				8,5 - 10,5	01IXA43014TT		
	16				10,5 - 12,5	01IXA43016TT		
3,2	6	6,7	1,3	3,3 - 3,4	1,5 - 2,5	01IXA43206TT	2500 N	1900 N
	8				2,5 - 4,5	01IXA43208TT		
	10				4,5 - 6,5	01IXA43210TT		
	12				6,5 - 8,5	01IXA43212TT		
	14				8,5 - 12	01IXA43214TT		
	16				12 - 15	01IXA43216TT		
4,0	6	8,4	1,7	4,1 - 4,2	1 - 2	01IXA44006TT	3500 N	2700 N
	8				2 - 4	01IXA44008TT		
	10				4 - 6	01IXA44010TT		
	12				6 - 8	01IXA44012TT		
	14				8 - 10	01IXA44014TT		
	16				10 - 12	01IXA44016TT		
4,8	6	10,1	2,0	4,9 - 5,0	1 - 2	01IXA44806TT	5000 N	4000 N
	8				1,5 - 3	01IXA44808TT		
	10				3 - 5	01IXA44810TT		
	12				5 - 7	01IXA44812TT		
	14				7 - 9	01IXA44814TT		
	16				9 - 11	01IXA44816TT		
6,0	8	12,6	2,5	6,1 - 6,2	2 - 4	01IXA46008TT	8800 N	6500 N
	10				4 - 6	01IXA46010TT		
	12				6 - 8	01IXA46012TT		
	14				7 - 9,5	01IXA46014TT		
	16				8 - 11	01IXA46016TT		
	18				9 - 13	01IXA46018TT		
6,4	10	13,4	2,7	6,5 - 6,6	2 - 4	01IXA46410TT	8800 N	6500 N
	12				4 - 6	01IXA46412TT		
	14				6 - 8	01IXA46414TT		
	16				7 - 10	01IXA46416TT		
	18				9 - 13	01IXA46418TT		
	20				13 - 16	01IXA46420TT		
22	25				14 - 17	01IXA46422TT		
					15 - 19	01IXA46425TT		

RIVETTI TENUTA STAGNA ACCIAIO INOX 304 / ACCIAIO INOX 420 T. TONDA

SEALED BLIND RIVETS STAINLESS STEEL 304 / STAINLESS STEEL 420 DOME HEAD

BECHERBLINDNIETE EDELSTAHL 304 / EDELSTAHL 420 FLACHKOPF

RIVETS ÉTANCHES INOX 304 / INOX 420 TÊTE PLATE

REMACHES ESTANCO INOX 304 / INOX 420 CABEZA ALOMADA

D +0,08/-0,15	L +1/-0,2	T max	K max	∅ foro/hole		CODICE code		
3,2	6	6,7	1,3	3,3 - 3,4		01TSTIX3206TT	2200 N	2000 N
	8					01TSTIX3208TT		
	9,5					01TSTIX3210TT		
	12					01TSTIX3212TT		
	14					01TSTIX3214TT		
4,0	6	8,4	1,7	4,1 - 4,2		01TSTIX4006TT	3500 N	3000 N
	8					01TSTIX4008TT		
	10					01TSTIX4010TT		
	12					01TSTIX4012TT		
	14					01TSTIX4014TT		
	16					01TSTIX4016TT		
4,8	8	10,1	2,0	4,9 - 5,0		01TSTIX4808TT	4400 N	4000 N
	9,5					01TSTIX4810TT		
	12					01TSTIX4812TT		
	14					01TSTIX4814TT		
	16					01TSTIX4816TT		
	20					01TSTIX4820TT		
6,4	12	13,4	2,7	6,5 - 6,6		01TSTIX6412TT	8000 N	6000 N
	14					01TSTIX6414TT		
	16					01TSTIX6416TT		
	20					01TSTIX6420TT		
						8 - 12		

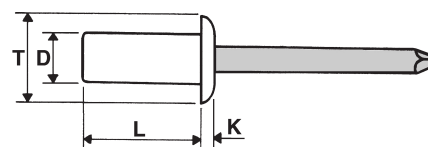
TST-IX - TT

- A RICHIESTA DISPONIBILI CON TESTA SVASATA
- COUNTERSUNK HEAD AVAILABLE ON DEMAND
- SENKKOPF BLINDNIETE AUF ANFRAGE LIEFERBAR
- SUR DEMANDE DISPONIBLES AUSSI TÊTE FRAISÉE
- BAJO PEDIDO DISPONIBLES CON CABEZA AVELLANADA

RIVETTI STRUTTURALI ACCIAIO INOX 304 / ACCIAIO INOX 304 T. TONDA

STRUCTURAL BLIND RIVETS STAINLESS STEEL 304 / STAINLESS STEEL 304 DOME HEAD
HOCHFESTE BLINDNIETE EDELSTAHL 304 / EDELSTAHL 304 FLACHKOPF
RIVETS DE STRUCTURE INOX 304 / INOX 304 TÊTE PLATE
REMACHES ESTRUCTUALES INOX 304 / INOX 304 CABEZA ALOMADA

- Elevata resistenza alle vibrazioni e buona tenuta ermetica
- *High resistance to vibrations and good seal*
- *Hohe Rüttelfestigkeit und gute Dichtigkeit*
- *Haute résistance aux vibrations et excellente tenue hermétique*
- *Excelente resistencia a las vibraciones y sellado*

MFX-TT IX

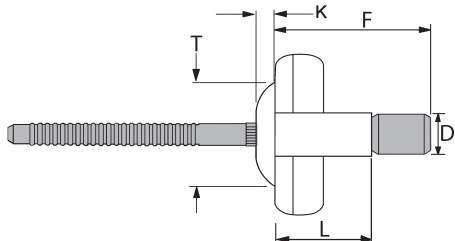

D	L	T	K	F	Ø		CODICE		
+0,08/-0,15	+1/-0,2	max	max	max	foro/hole		code		
4,8	10	10,2	2,5	21,4	4,9 - 5,2	1,6 - 6,4	01MFX4810TTIX	4400	5780
	14						N	N	
6,4	14	13,5	3,2	28,4	6,6 - 7,0	2 - 9,5	01MFX6414TTIX	8220	10670
	20						N	N	

- DA UTILIZZARE CON UGELLO STANDARD
- TO BE USED WITH STANDARD NOSE PIECE
- KEIN SONDERMUNDSTÜCK NOTWENDIG
- À UTILISER AVEC BUSE STANDARD
- PARA SER USADO CON EL CABEZAL STANDARD

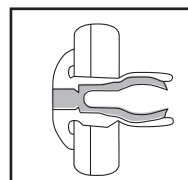

RIVETTI STRUTTURALI ACCIAIO INOX 304 / ACCIAIO INOX 304 T. SVASATA

STRUCTURAL BLIND RIVETS STAINLESS STEEL 304 / STAINLESS STEEL 304 COUNTERSUNK HEAD
HOCHFESTE BLINDNIETE EDELSTAHL 304 / EDELSTAHL 304 SENKKOPF
RIVETS DE STRUCTURE INOX 304 / INOX 304 TÊTE FRAISÉE
REMACHES ESTRUCTUALES INOX 304 / INOX 304 CABEZA AVELLANADA

- Elevata resistenza alle vibrazioni e buona tenuta ermetica
- *High resistance to vibrations and good seal*
- *Hohe Rüttelfestigkeit und gute Dichtigkeit*
- *Haute résistance aux vibrations et excellente tenue hermétique*
- *Excelente resistencia a las vibraciones y sellado*

MFX-TS IX

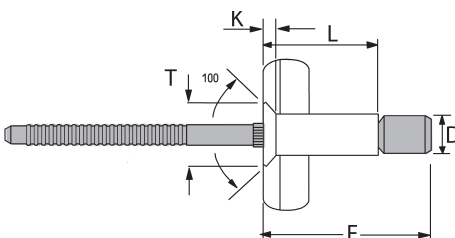

D	L	T	K	F	Ø		CODICE		
					foro/hole		code		
4,8	12	9,0	2,0	20	4,9 - 5,1	3,6 - 7,9	01MFX4813TSIX	4500	6000
	16						N	N	
6,4	16	11,0	2,2	28	6,6 - 7,0	5 - 12,0	01MFX6417TSIX	8200	10500
	22						N	N	

- DA UTILIZZARE CON UGELLO STANDARD
- TO BE USED WITH STANDARD NOSE PIECE
- KEIN SONDERMUNDSTÜCK NOTWENDIG
- À UTILISER AVEC BUSE STANDARD
- PARA SER USADO CON EL CABEZAL STANDARD

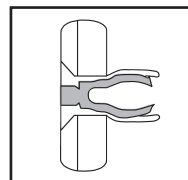

RIVETTI STRUTTURALI ACCIAIO INOX 304 / ACCIAIO INOX 304 T. TONDA



















STRUCTURAL BLIND RIVETS STAINLESS STEEL 304 / STAINLESS STEEL 304 DOME HEAD

HOCHFESTE BLINDNIETE EDELSTAHL 304 / EDELSTAHL 304 FLACHKOPF

RIVETS DE STRUCTURE INOX 304 / INOX 304 TÊTE PLATE

REMACHES ESTRUCTUALES INOX 304 / INOX 304 CABEZA ALOMADA

- La controtesta più larga garantisce maggiore tenuta e non deforma i materiali a lastra sottile. E' resistente all'acqua ed alle vibrazioni.
- *For thin sheet applications. Good resistance to vibrations and good seal*
- *Die Schließkopfformung dient für eine höhere Festigkeit und verformt nicht die ganz dünne Bleche. Hohe Rüttelfestigkeit und gute Dichtigkeit*
- *Pour applications sur tôle fine. Bonne résistance aux vibrations et bonne tenue.*
- *Para aplicación en chapa de poco grosor. Buena resistencia a las vibraciones y buen sellado.*

D +0,08/-0,15	L +1/-0,2	T	K max	∅ foro/hole		CODICE code				
3,2	6,6	6,7	1,3	3,3-3,4		1 - 3 01MBX3207TTIX				
	3 - 5 01MBX3209TTIX					2000 N			1600 N	
	5 - 7 01MBX3211TTIX									
4,0	8	8,4	1,7	4,1-4,2		1 - 3 01MBX4008TTIX				
	3 - 5 01MBX4010TTIX					3800 N			4200 N	
	5 - 7 01MBX4012TTIX									
4,8	10	10,1	2,0	4,9-5,0		1,5 - 3,5 01MBX4810TTIX				
	3,5 - 6 01MBX4812TTIX					5000 N			5500 N	
	6 - 8,5 01MBX4814TTIX									
	8,5 - 11 01MBX4816TTIX									
6,4	9	13,4	2,7	6,5-6,6		1,5 - 3,5 01MBX6409TTIX				
	10					2,8 - 4,8 01MBX6410TTIX				
	11					3,4 - 5,4 01MBX6411TTIX				
	12					4,8 - 6,8 01MBX6412TTIX				
	14					6,8 - 8,8 01MBX6414TTIX				
	16					8,8 - 10,8 01MBX6416TTIX				
	18					10,8 - 12,8 01MBX6418TTIX				
7,8	13,5	16	3,8	8,0-8,3		4 - 7 01MBX7814TTIX				
	16,5					7 - 10 01MBX7817TTIX			19130 N	11770 N
	19,5					10 - 13 01MBX7820TTIX			20600 N	
	22,5					13 - 16 01MBX7823TTIX			20600 N	

MBX - TT IX

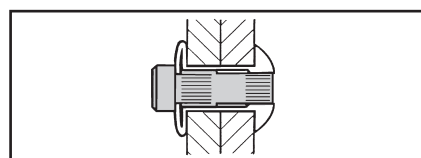
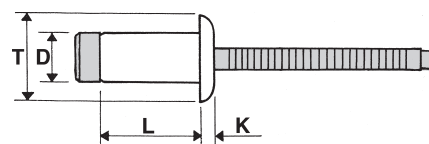

- A RICHIESTA DISPONIBILI CON TESTA SVASATA
- COUNTERSUNK HEAD AVAILABLE ON DEMAND
- SENKKOPF BLINDNIETE AUF ANFRAGE LIEFERBAR
- SUR DEMANDE DISPONIBLES AUSSI TÊTE FRAISÉE
- BAJO PEDIDO DISPONIBLES CON CABEZA AVELLANADA

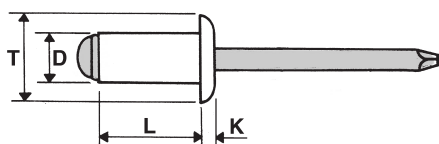
RIVETTI RAME / ACCIAIO ZINCATO TESTA TONDA*BLIND RIVETS COPPER / STEEL ZINC PLATED DOME HEAD**BLINDNIETE KUPFER / STAHL VZ FLACHKOPF**RIVETS CUIVRE / ACIER ZINGUÉ TÊTE PLATE**REMACHES COBRE / ACERO CINCADO CABEZA ALOMADA***CU - TT**

D +0,08/-0,15	L +1/-0,2	T max	K max	∅ foro/hole		CODICE code			
3,0	5	6,3	1,3	3,1 - 3,2		01CU3005TT	min	min	
	6								0,5 - 2
	7								1 - 3
	9								2 - 4
	11								4 - 6
	12								6 - 8
3,2	6	6,7	1,3	3,3 - 3,4		01CU3206TT	950 N	760 N	
	7								1 - 3
	9								2 - 4
	11								4 - 6
	12								6 - 8
	12								7 - 9
3,4	7	7,1	1,4	3,5 - 3,6		01CU3407TT	1000 N	800 N	
	9								2 - 4
	11								4 - 6
	12								6 - 8
	12								7 - 9
	14								9 - 11
4,0	6	8,4	1,7	4,1 - 4,2		01CU4006TT	1400 N	1500 N	
	7								1 - 2
	9								2 - 3,5
	11								4 - 5,5
	12								6 - 7,5
	14								7 - 8,5
4,8	12	10,1	2,0	4,9 - 5,0		01CU4011TT	2500 N	2000 N	
	14								5,5 - 7,5
	16								7,5 - 9,5
	18								9,5 - 11,5
	18								11,5 - 13,5
	20								13,5 - 15,5

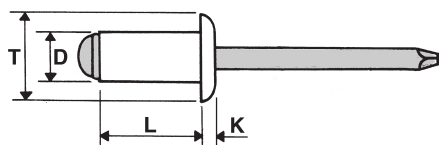
RIVETTI RAME / OTTONE TESTA TONDA*BLIND RIVETS COPPER / BRASS DOME HEAD**BLINDNIETE KUPFER / MESSING FLACHKOPF**RIVETS CUIVRE / LAITON TÊTE PLATE**REMACHES COBRE / LATÓN CABEZA ALOMADA***CUO - TT**

D +0,08/-0,15	L +1/-0,2	T max	K max	∅ foro/hole		CODICE code			
3,2	6	6,7	1,3	3,3 - 3,4		01CUO3206TT	min	min	
	7								1 - 3
	9								2 - 4
	11								4 - 6
	12								6 - 8
	12								7 - 9
3,4	7	7,1	1,4	3,5 - 3,6		01CUO3407TT	1000 N	800 N	
	9								2 - 4
	11								4 - 6
	12								6 - 8
	12								7 - 9
	14								9 - 11
4,0	6	8,4	1,7	4,1 - 4,2		01CUO4006TT	1800 N	1500 N	
	7								1 - 2
	9								2 - 3,5
	11								4 - 5,5
	12								6 - 7,5
	14								7 - 8,5
4,8	12	10,1	2,0	4,9 - 5,0		01CUO4011TT	2500 N	2000 N	
	14								5,5 - 7,5
	16								7,5 - 9,5
	16								9,5 - 11,5

RIVETTI TENUTA STAGNA RAME / ACCIAIO TESTA TONDA

SEALED BLIND RIVETS COPPER / STEEL DOME HEAD

BECHERBLINDNIETE KUPFER / STAHL FLACHKOPF

RIVETS ÉTANCHES CUIVRE / ACIER TÊTE PLATE

REMACHES ESTANCOS COBRE / ACERO CABEZA ALOMADA

D	L	T	K	∅		CODICE			
+0,08/-0,15	+1/-0,2	max	max	foro/hole		code			
3,2	6	6,7	1,3	3,3 - 3,4		01TSTCU3206TT 01TSTCU3207TT 01TSTCU3209TT 01TSTCU3212TT		1420 N	1020 N
	7,5								
	9								
	12								
4,0	8	8,4	1,7	4,1 - 4,2		01TSTCU4008TT 01TSTCU4009TT 01TSTCU4012TT		2260 N	1550 N
	9,5								
	12,5								
4,8	8,5	10,1	2,0	4,9 - 5,0		01TSTCU4808TT 01TSTCU4811TT		3110 N	2130 N
	11,5								

TST-CU - TT

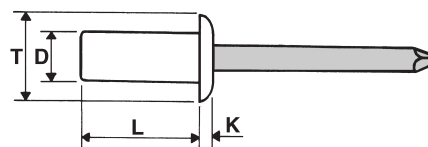

RIVETTI TENUTA STAGNA RAME / ACCIAIO INOX A2 TESTA TONDA

SEALED BLIND RIVETS COPPER / STAINLESS STEEL A2 DOME HEAD

BECHERBLINDNIETE KUPFER / EDELSTAHL A2 FLACHKOPF

RIVETS ÉTANCHES CUIVRE / INOX A2 TÊTE PLATE

REMACHES ESTANCOS COBRE / INOX A2 CABEZA ALOMADA

D	L	T	K	∅		CODICE			
+0,08/-0,15	+1/-0,2	max	max	foro/hole		code			
3,2	6	6,7	1,3	3,3 - 3,4		01TSTCUX3206TT 01TSTCUX3207TT 01TSTCUX3209TT 01TSTCUX3212TT		1300 N	850 N
	7,5								
	9								
	12								
4,0	8	8,4	1,7	4,1 - 4,2		01TSTCUX4008TT 01TSTCUX4009TT		2000 N	1350 N
	9,5								

TST-CUX - TT

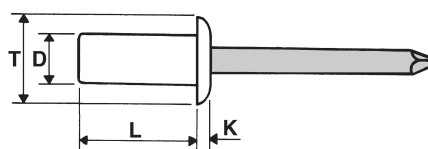

RIVETTI CUPRO NICHEL / INOX A2 TESTA TONDA

BLIND RIVETS COPPER NICKEL / STAINLESS STEEL A2 DOME HEAD

BLINDNIETE KUPFERNICKEL / EDELSTAHL A2 FLACHKOPF

RIVETS CUPRONICKEL / INOX A2 TÊTE PLATE

REMACHES COBRE NIQUEL / INOX A2 CABEZA ALOMADA

D	L	T	K	∅		CODICE			
+0,08/-0,15	+1/-0,2	max	max	foro/hole		code			
3,2	6	6,7	1,3	3,3 - 3,4		01TUX3206TT 01TUX3207TT 01TUX3209TT 01TUX3211TT 01TUX3212TT		1900 N	1400 N
	7								
	9								
	11								
	12								
4,0	7	8,4	1,7	4,1 - 4,2		01TUX4007TT 01TUX4009TT 01TUX4011TT 01TUX4012TT 01TUX4014TT 01TUX4016TT 01TUX4018TT		3000 N	2200 N
	9								
	11								
	12								
	14								
	16								
	18								
	20								
4,8	7	10,1	2,0	4,9 - 5,0		01TUX4807TT 01TUX4809TT 01TUX4811TT 01TUX4812TT 01TUX4814TT 01TUX4816TT 01TUX4818TT 01TUX4820TT		3700 N	3300 N
	9								
	11								
	12								
	14								
	16								
	18								
	20								

TUX - TT

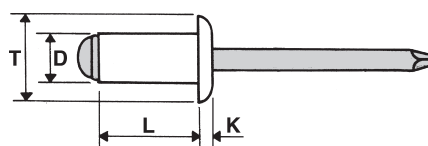

RIVETTATRICI MANUALI PER RIVETTI A STRAPPO

HAND TOOLS FOR BLIND RIVETS

HANDWERKZEUGE FÜR BLINDNIETE

OUTILS MANUELS POUR RIVETS AVEUGLES

HERRAMIENTAS DE MANO PARA REMACHES CLAVO



Ugello unico, non occorre sostituirlo
No need to change the nosepiece
Nur ein Mundstück. Muß man nicht wechseln
Il ne faut pas changer le nez
No se necesita cambiar el cabezal

CODICE / CODE

02150

UTILIZZO - CAPACITY

Alluminio / Acciaio / Rame
Aluminium / Steel / Copper

ø 2,4 - 5 mm.

Inox

Stainless Steel

ø 2,4 - 4 mm.

LUNGHEZZA - Length

253 mm.

UGELLI

Nose Pieces

ø 2,4 - 5 mm.

MATERIALE DEL CORPO

Ferro

Body Material

Steel

PESO - Weight

0,6 Kg.

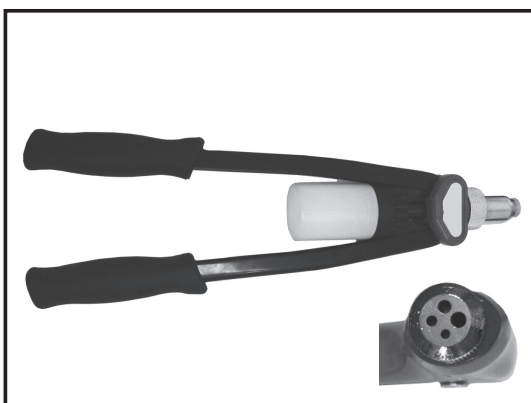

Ugello unico, non occorre sostituirlo
No need to change the nosepiece
Nur ein Mundstück. Muß man nicht wechseln
Il ne faut pas changer le nez
No se necesita cambiar el cabezal

CODICE / CODE

02260

UTILIZZO

tutti i materiali e rivetti strutturali

CAPACITY

all materials and structural rivets ø 3,2 - 6,4 mm.

LUNGHEZZA - Length

333 mm.

UGELLI

Nose Pieces

ø 3,2 - 6,4 mm.

MATERIALE DEL CORPO

Ferro

Body Material

Steel

PESO - Weight

2,0 Kg.

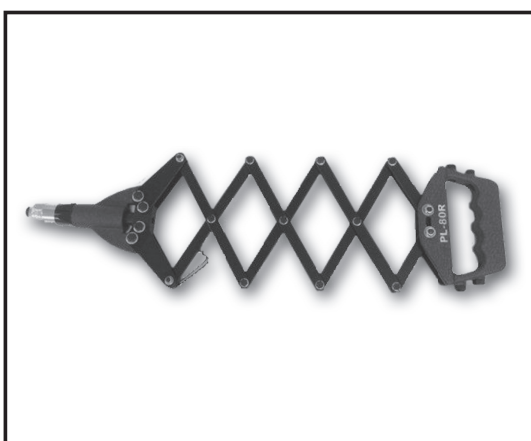

CODICE / CODE

02
PANTOGRAFO

UTILIZZO

tutti i materiali

CAPACITY

all materials

ø 3 - 6,4 mm.

LUNGHEZZA - Length

500 mm.

UGELLI

Nose Pieces

ø 3 - 6,4 mm.

MATERIALE DEL CORPO

Ferro

Body Material

Steel

PESO - Weight

2,3 Kg.

ALTEZZA - Height

171 mm.

RIVETTATRICI OLEOPNEUMATICHE PER RIVETTI A STRAPPO

OLEOPNEUMATIC TOOLS FOR BLIND RIVETS

OLEO PNEUMATISCHE BLINDNIETE WERKZUEGE

OUTILS OLEOPNEUMATIQUES POUR RIVETS AVEUGLES

HERRAMIENTA OLEONEUMÁTICAS PARA REMACHES CLAVO

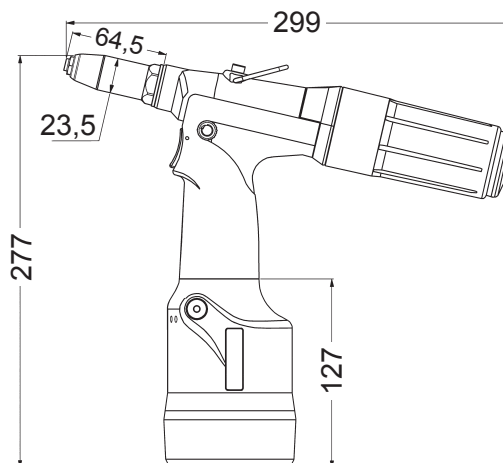

02F1

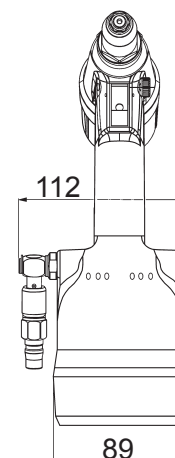

CODICE CODE	CARATTERISTICHE TECHNICAL FEATURES				UTILIZZO CAPACITY				
	PRESSIONE DI UTILIZZO PRESSURE REQUIRED	PESO WEIGHT	CORSA STROKE	FORZA TRACTION POWER	RIVETTO Ø	ALLUMINIO / ACCIAIO ALUMINIUM/STEEL	ACCIAIO / ACCIAIO STEEL/STEEL	RAME / ACCIAIO COPPER/STEEL	INOX / INOX STAINLESS STEEL/ STAINLESS STEEL
02F1	5 - 7 BAR	1,1 Kg	18 mm	7 KN	2,4 mm	●	●	●	●
					3 - 3,2 mm	●	●	●	●
					4 mm	●	●	●	●
					4,8 - 5 mm	●			

CODICE CODE	PRODOTTO PRODUCT	CARATTERISTICHE TECHNICAL FEATURES
02CLAMPJAWSF1	MORSETTI DI RICAMBIO SPARE CLAMPING JAWS	No. 1 Set (3 Pcs)
02U24F1	UGELLI DI RICAMBIO SPARE NOSEPIECES	Diam. 2,4 mm
02U32F1	UGELLI DI RICAMBIO SPARE NOSEPIECES	Diam. 3,2 mm
02U40F1	UGELLI DI RICAMBIO SPARE NOSEPIECES	Diam. 4,0 mm
02U48F1	UGELLI DI RICAMBIO SPARE NOSEPIECES	Diam. 4,8 - 5 mm

Morsetto
Clamping Jaw



Ugello
Nosepiece



- Ugelli prolungati a pag. 41
Longer nosepieces at page 41

RIVETTATRICI OLEOPNEUMATICHE PER RIVETTI A STRAPPO

OLEOPNEUMATIC TOOLS FOR BLIND RIVETS

OLEO PNEUMATISCHE BLINDNIETE WERKZUEGE

OUTILS OLEOPNEUMATIQUES POUR RIVETS AVEUGLES

HERRAMIENTA OLEONEUMÁTICAS PARA REMACHES CLAVO

02F2

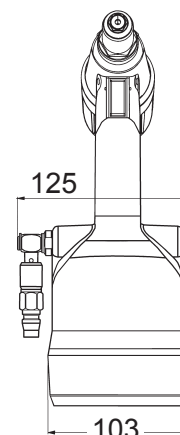
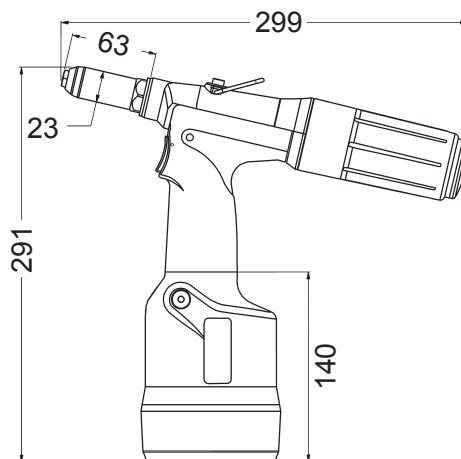

CODICE CODE	CARATTERISTICHE TECHNICAL FEATURES				UTILIZZO CAPACITY				
	PRESSIONE DI UTILIZZO PRESSURE REQUIRED	PESO WEIGHT	CORSA STROKE	FORZA TRACTION POWER	RIVETTO Ø	ALLUMINIO / ACCIAIO ALUMINIUM/STEEL	ACCIAIO / ACCIAIO STEEL/STEEL	RAME / ACCIAIO COPPER/STEEL	INOX / INOX STAINLESS STEEL/ STAINLESS STEEL
02F2	5 - 7 BAR	1,3 Kg	20 mm	10 KN	3,2 mm	●	●	●	●
					4 mm	●	●	●	●
					4,8 - 5 mm	●	●	●	●
					6 mm	●			
					6,4 mm	●			

CODICE CODE	PRODOTTO PRODUCT	CARATTERISTICHE TECHNICAL FEATURES
02CLAMPJAWSF2/F3	MORSETTI DI RICAMBIO SPARE CLAMPING JAWS	No. 1 Set (3 Pcs)
02U32F2	UGELLI DI RICAMBIO SPARE NOSEPIECES	Diam. 3,2 mm
02U40F2/F3	UGELLI DI RICAMBIO SPARE NOSEPIECES	Diam. 4,0 mm
02U48F2/F3	UGELLI DI RICAMBIO SPARE NOSEPIECES	Diam. 4,8 - 5 mm
02U64F2/F3	UGELLI DI RICAMBIO SPARE NOSEPIECES	Diam. 6,4 mm

Morsetto
Clamping Jaw



Ugello
Nosepiece



- Ugelli e teste prolungate a pag. 41
Longer nosepieces and extended head at page 41

RIVETTATRICI OLEOPNEUMATICHE PER RIVETTI A STRAPPO

OLEOPNEUMATIC TOOLS FOR BLIND RIVETS

OLEO PNEUMATISCHE BLINDNIETE WERKZUEGE

OUTILS OLEOPNEUMATIQUES POUR RIVETS AVEUGLES

HERRAMIENTA OLEONEUMÁTICAS PARA REMACHES CLAVO

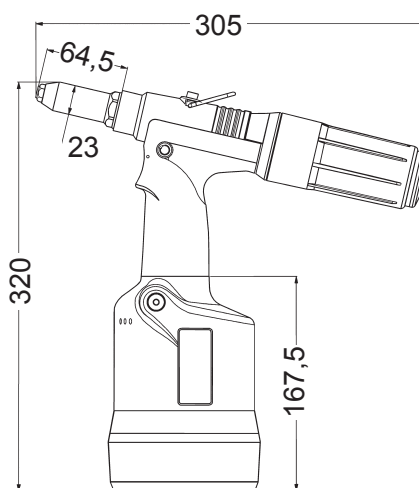

02F3

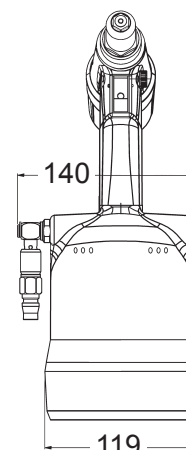

CODICE CODE	CARATTERISTICHE TECHNICAL FEATURES				UTILIZZO CAPACITY				
	PRESSIONE DI UTILIZZO PRESSURE REQUIRED	PESO WEIGHT	CORSA STROKE	FORZA TRACTION POWER	RIVETTO Ø	ALLUMINIO / ACCIAIO ALUMINIUM/STEEL	ACCIAIO / ACCIAIO STEEL/STEEL	RAME / ACCIAIO COPPER/STEEL	INOX / INOX STAINLESS STEEL/ STAINLESS STEEL
02F3	5 - 7 BAR	1,6 Kg	26,7 mm	15.2 KN	4 mm	●	●	●	●
					4,8 - 5 mm	●	●	●	●
					6.0 mm	●	●	●	●
					6.4 mm	●	●	●	●
					STRUTTURALI STRUCTURAL RIVETS	●	●		●

CODICE CODE	PRODOTTO PRODUCT	CARATTERISTICHE TECHNICAL FEATURES
02CLAMPJAWSF2/F3	MORSETTI DI RICAMBIO SPARE CLAMPING JAWS	No. 1 Set (3 Pcs)
02U40F2/F3	UGELLI DI RICAMBIO SPARE NOSEPIECES	Diam. 4,0 mm
02U48F2/F3	UGELLI DI RICAMBIO SPARE NOSEPIECES	Diam. 4,8 - 5 mm
02U64F2/F3	UGELLI DI RICAMBIO SPARE NOSEPIECES	Diam. 6,4 mm
02U48F3M	UGELLI DI RICAMBIO per MONOFIX SPARE NOSEPIECES for MONOFIX	Diam. 4,8 mm
02U64F3M	UGELLI DI RICAMBIO per MONOFIX SPARE NOSEPIECES for MONOFIX	Diam. 6,4 mm

Morsetto
Clamping Jaw



Ugello
Nosepiece



- Ugelli e teste prolungate a pag. 41
Longer nosepieces and extended head at page 41

RIVETTATRICI OLEOPNEUMATICHE PER RIVETTI A STRAPPO

OLEOPNEUMATIC TOOLS FOR BLIND RIVETS

OLEO PNEUMATISCHE BLINDNIETE WERKZUEGE

OUTILS OLEOPNEUMATIQUES POUR RIVETS AVEUGLES

HERRAMIENTA OLEONEUMÁTICAS PARA REMACHES CLAVO

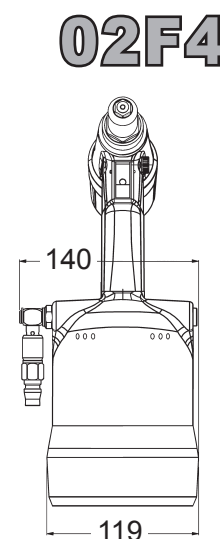
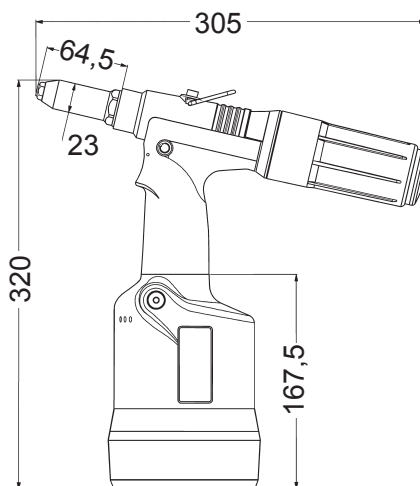

DA UTILIZZARE CON I RIVETTI STRUTTURALI MBX
 SUITABLE FOR MBX SERIES STRUCTURAL RIVETS
 ZUR VERARBEITUNG VON STRUKTURELLEN MBX BLINDNIETE
 À UTILISER AVEC LES RIVETS DE STRUCTURE MBX
 PARA UTILIZAR CON REMACHES CLAVO ESTRUCTURALES MBX

CODICE CODE	CARATTERISTICHE TECHNICAL FEATURES				UTILIZZO CAPACITY				
	PRESSIONE DI UTILIZZO PRESSURE REQUIRED	PESO WEIGHT	CORSA STROKE	FORZA TRACTION POWER	RIVETTO Ø	ALLUMINIO / ACCIAIO ALUMINIUM/STEEL	ACCIAIO / ACCIAIO STEEL/STEEL	RAME / ACCIAIO COPPER/STEEL	INOX / INOX STAINLESS STEEL/ STAINLESS STEEL
02F4	5 - 7 BAR	1,6 Kg	19 mm	18 KN	4,8 - 5 mm	●	●	●	●
					6.0 mm	●	●	●	●
					6.4 mm	●	●	●	●
					STRUTTURALI MBX MBX STRUCTURAL RIVETS	●	●		●

CODICE CODE	PRODOTTO PRODUCT	CARATTERISTICHE TECHNICAL FEATURES
02CLAMPJAWSF4	MORSETTI DI RICAMBIO SPARE CLAMPING JAWS	No. 1 Set (3 Pcs)
02U48F2/F3/F4	UGELLI DI RICAMBIO SPARE NOSEPIECES	Diam. 4,8 - 5 mm
02U60F2/F3/F4	UGELLI DI RICAMBIO SPARE NOSEPIECES	Diam. 6,0 mm
02U64F2/F3/F4	UGELLI DI RICAMBIO SPARE NOSEPIECES	Diam. 6,4 mm

Morsetto
Clamping Jaw



Ugello
Nosepiece



- Ugelli e teste prolungate a pag. 41
 Longer nosepieces and extended head at page 41

UGELLI E TESTE PROLUNGATE PER RIVETTATRICI F1/F2/F3/F4

LONGER NOSEPIECES AND EXTENDED HEADS FOR OLEPNEUMATIC TOOLS F1/F2/F3/F4

VERLÄNGERTE MUNDSTÜCKE UND KÖPFE FÜR DIE OLEO-PNEUMATISCHE GERÄTE F1/F2/F3/F4

BUSES ET TÊTES RALLONGÉES POUR OUTILS À RIVETER F1/F2/F3/F4

BOQUILLAS Y CABEZALES PROLONGADOS PARA LAS REMACHADORAS F1/F2/F3/F4

SE SI UTILIZZANO UGELLI PROLUNGATI IL MANDRINO DEVE USCIRE DALL'UGELLO ALMENO DI 12 MM

WHEN USING LONGER NOSEPIECES MANDREL LENGTH MUST PROTRUDE AT LEAST 12 MM

WENN VERLÄNGERTE MUNDSTÜCKE VERWENDET WERDEN, MUß DER DORN MIN 12 MM HERAUSRAGEN

DANS LE CAS D'UTILISATION DE BUSES RALLONGÉES, LE MANDRIN DOIT SORTIR DE LA BUSE D'AU MOINS 12 MM

SI SE USAN BOQUILLAS PROLONGADAS EL MANDRIL DEBE SOBRESALIR DE LA BOQUILLA AL MENOS 12 MM

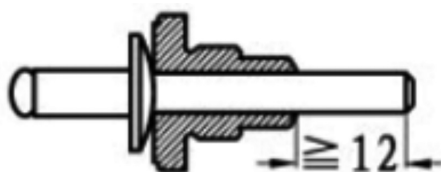

UGELLI PROLUNGATI PER F1 – F2

Longer Nosepieces for F1 - F2

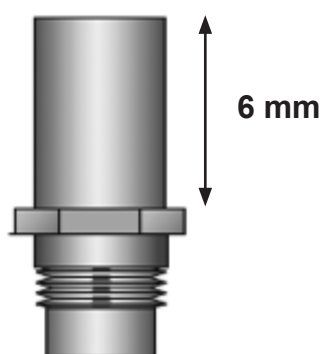

6 mm

Ø 2,4 (F1) codice / code 02UP624F1

Ø 3,0 - 3,2 (F1 - F2) codice / code 02UP632F1F2

Ø 4,0 (F1 - F2) codice / code 02UP640F1F2

Ø 4,8 (F1 - F2) codice / code 02UP648F1F2

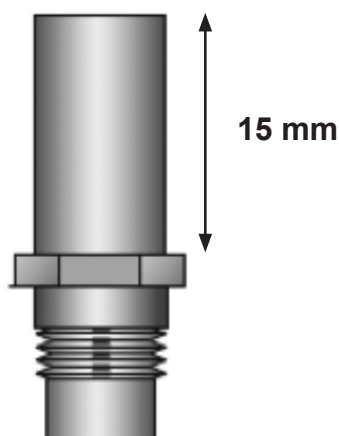

15 mm

Ø 3,0 - 3,2 (F1 - F2) codice / code 02UP1532F1F2

Ø 4,0 (F1 - F2) codice / code 02UP1540F1F2

Ø 4,8 (F1 - F2) codice / code 02UP1548F1F2

TESTE PROLUNGATE PER F2 - F3 - F4

Extended Heads for F2 - F3 - F4

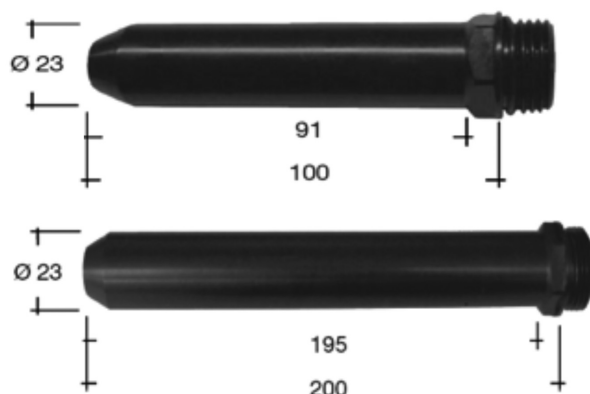

LUNGHEZZA / LENGTH 100 mm

Codice / Code 02TP100F2F3

LUNGHEZZA / LENGTH 200 mm

Codice / Code 02TP200F2F3

1

42.44

RIVETTATRICE A BATTERIA PER RIVETTI A STRAPPO

BATTERY TOOL FOR BLIND RIVETS

AKKU BLINDNIETGERÄT

RIVETEUSE SUR BATTERIE POUR RIVETS AVEUGLES

REMACHADORA A BATERIA PARA REMACHES



SECONDA BATTERIA
IN DOTAZIONE!
Second battery included!

CODICE CODE	CARATTERISTICHE TECHNICAL FEATURES						UTILIZZO CAPACITY				
	TENSIONE della BATTERIA BATTERY POWER	PESO con batteria TOTAL WEIGHT	CORSA STROKE	FORZA di TRAZIONE TRACTION POWER	AMPERE A	TEMPO di RICARICA CHARGING TIME	RIVETTO Ø	ALLUMINIO / ACCIAIO ALUMINIUM/STEEL	ACCIAIO / ACCIAIO STEEL/STEEL	RAME / ACCIAIO COPPER/STEEL	INOX / INOX STAINLESS STEEL/ STAINLESS STEEL
02RBZ	18V	1,722 Kg	26 mm	8,2 Kn	2.0 Ah	105 min.	3,2 mm	●	●	●	●
							4 mm	●	●	●	●
							4,8 mm	●	●	●	●
							6,4 mm	●			

CODICE CODE	PRODOTTO PRODUCT
02BRTZ18	BATTERIA per 02RBZ e 90TBZ BATTERY FOR 02RBZ AND 90TBZ
02CLAMPJAWSRBZ	MORSETTI per 02RBZ (SET 3 PEZZI) JAWS FOR 02RBZ (SET 3 PCS)
02U32RBZ	UGELLI 3.2 per 02RBZ NOSEPIECE 3.2 FOR 02RBZ
02U40RBZ	UGELLI 4.0 per 02RBZ NOSEPIECE 4.0 FOR 02RBZ
02U48RBZ	UGELLI 4.8 per 02RBZ NOSEPIECE 4.8 FOR 02RBZ
02U64RBZ	UGELLI 6.4 per 02RBZ NOSEPIECE 6.4 FOR 02RBZ

2



INSERTI FILETTATI
 THREADED INSERTS
 BLINDNIETMUTTERN
 INSERTS FILETES

FIXI

3



AUTOFISSANTI
 SELF CLINCHING FASTENERS
 EINPRESSBEFESTIGER

FIXI

4

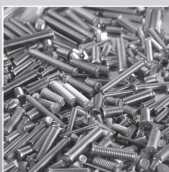

PERNI A SALDARE
 WELDING STUDS

FIXI

5



FISSAGGI PER
 MATERIE PLASTICHE
 FASTENERS FOR PLASTICS

FIXI

6



FILETTI RIPORTATI
 WIRE INSERTS

FIXI

FIXI®

SISTEMI DI FISSAGGIO MECCANICI

Via Bellardi, 40/A - 10146 Torino (Italy) - Tel. 0039 011.7072398 / 7070877 - Fax 0039 011.7072521
 E-mail: fissaggi@fixi.it - www.fixi.it

FIXI® **VAL**

VALLE D'AOSTA - PIEMONTE - LIGURIA

Via Valgioie, 94 - 10146 Torino Italy
 Tel. 0039 011.0882009 - Fax 0039 011.0882012
 E-mail: info@fixivpl.it - www.fixi.it

FIXI® **FL**

LOMBARDIA - CANTON TICINO

Via Delle Gallarane, 10/12 - 22046 Merone (CO) Italy
 Tel. 0039 031.3333486 - Fax 0039 031.3339064
 E-mail: info@fixilombardia.it - www.fixi.it

FIXI® **3V**

TRENTINO - VENETO - FRIULI

Via Keplero, 4G/H - Z.I. di Tognana - 35028 Piove di Sacco (PD) Italy
 Tel. 0039 049.8079285 - Fax 0039 049.8087725
 E-mail: trevenezie@fixitrevenezie.it - www.fixi.it

FIXI® **ets**

EMILIA ROMAGNA - TOSCANA - SARDEGNA

Via Secci, 4 - 40132 Bologna Italy
 Tel. 0039 051.0353243 - Fax 0039 051.0353244
 E-mail: amministr@fixiets.it - www.fixi.it

FIXI® **u.g**

MARCHE - UMBRIA - ABRUZZO - MOLISE

Via Roma, 10 - 63078 Fr. Pagliare del Tronto Spinetoli (AP) Italy
 Tel. 0039 0736.814110 - Fax 0039 0736.984002
 E-mail: info@fixiua.it - www.fixi.it

FIXI® **csi**

CENTRO SUD ITALIA

Via Arno, 50 - 63082 Castel di Lama (AP) (ITALY)
 Tel. 0039 0736.812922 - Fax 0039 0736.812922
 E-mail: info@fixicentrosud.it - www.fixi.it



Marzo 2017